

FHD 144Hz

Professional and Versatile LED Monitor

UltraView

UltraView FHD 144Hz LED monitor supports high frequency 1920 x 1080 resolution to be presented, achieving ultimate picture quality. Improved energy efficiency and fan-less architecture provides professional-use durability and around-the-clock operation.

MF27"



UltraView FHD 144Hz high frequency professional LED is more than just a standalone monitor. UltraView has a variety of embedded modules including HDMI Decoder, HDMI Extender, Multi-Monitor OSD Controller, SDI Input. The embedded modules give you the video remote management and transmission for multiple monitors over network.

As a versatile FHD monitor, UltraView FHD professional LED is meticulously designed to meet professional and environmental demands including Front protection, Anti-reflective/Vandal proof glass, DC power input, Brightness dimming and Mounting kit for VESA-mount, Universal-mount, Overhead tilted wall-mount, Desktop stand and Panel-mount.

With over 25 years' production experience, the UltraView structure is well-engineered and manufactured by our own CNC facilities and team of experts to ensure its ruggedness, mobility and quality, as well as being suitable for harsh environment applications. The structure can be customized if required to facilitate monitor installation. Our knowledgeable engineers are able to provide frame customization for specific dimensions, color, metal treatment, screen printing, bezel and mounting.

Product Highlights



Key Benefits

- ▶ 144 Hz high frequency refresh rate
- ▶ 1920 x 1080 native FHD resolution
- ▶ 16.7 M colors
- ▶ PIP Sub-screen & PBP Dual-screen viewing efficiency
- ▶ VGA + DVI-D + HDMI-1.4 video input
- ▶ Video decoding capability up to 1080p (option)
- ▶ Rugged structure ensures high mobility
- ▶ IP65 front protection (NAP series)
- ▶ Professional-use durability & around-the-clock operation
- ▶ 2-year standard warranty (upgradable up to 5 years)

Applications

- Military / Defense
- eSport
- Gaming
- Video Editing
- Broadcasting / Advertising
- Traffic control / Command center
- Surveillance system
- Vehicle mount display

Options

- DC power
- Touchscreen
- IP65 front protection
- Custom chassis & mounting
- HDMI decoder & extender
- HDMI quad display 1080p
- Multi monitor OSD control module
- 3G / HD / SD-SDI input module
- Portrait mode module
- Auto dimming
- Manual dimming

MF27"

Professional and Versatile LED Monitor

UltraView

MF27

6mm aluminum front bezel



AP-MF27

Aluminum front cover

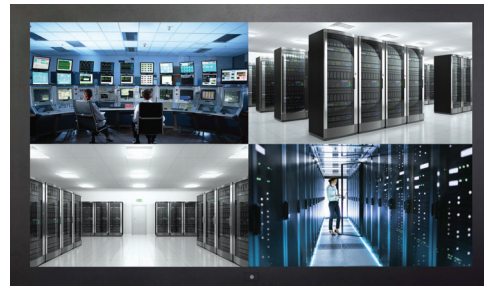

DP-MF27

6mm aluminum front bezel
NEMA 4 / IP65 front protection



NAP-MF27

Universal open frame



OP-MF27

Chassis customization

- ▶ Dimension
- ▶ Color & Treatment
- ▶ Screen Printing
- ▶ Stainless Steel Bezel

Option — Touchscreen & Glass Protection

Touchscreen type	MF27
Projected Capacitive 10-point	✓
Anti-reflective Glass	✓
Vandal Proof Glass	✓

Specification : Projected Capacitive 10-point Touch

	TPC-10 Multi-touch
Technology	Projected Capacitive
Touch Point	10 point touch standard (special requirement available)
Input Type	Finger or Capacitive Stylus
Resolution	4096 x 4096
Touch Point Accuracy	± 2 mm
Response Speed	< 5 ms
Activation Force	< 5 g
Surface Hardness	6H
Light Transmission	> 85%
Haze	3%↓
Durability	50 million touches
Top Layer	3 mm Glass
Bottom Layer	1.1 mm Sensor Glass
Thickness	4.3 ± 0.25 mm
Connector	USB
Compatibility	Windows / Linux / Android / Mac

Part no. : TPC10

* Not applicable to NAP series

** Dimension change required

Options — DC Power

		12V	24V	48V	125V
Input rating	Input voltage	12-Volt	24-Volt	48-Volt	110-Volt
	Input range	9 ~ 18V	18 ~ 36V	36 ~ 75V	66 ~ 160V
Input current	No load	50 mA	50 mA	50 mA	35 mA
	Full load	4950 mA	2450 mA	1220 mA	749 mA
Output rating	Output voltage	12-Volt	12-Volt	12-Volt	12-Volt
	Output current	4.16A	4.16A	4.16A	6.25A
Efficiency		84%	85%	85%	91%

Part no. : 12VDC

24VDC

48VDC

125VDC

Options — Video Management & Transmission over Network

Embedded HDMI Decoder Module 1080p over IP

- Decodes RTSP, RTMP, UDP, HTTP, HLS protocols
- Supports video resolutions up to 1080p / 60Hz
- Unicast and multicast support
- Operates on standard 1000Mb Ethernet networks
- Built-in Web UI for configuration and control
- Excellent image quality with very low delay

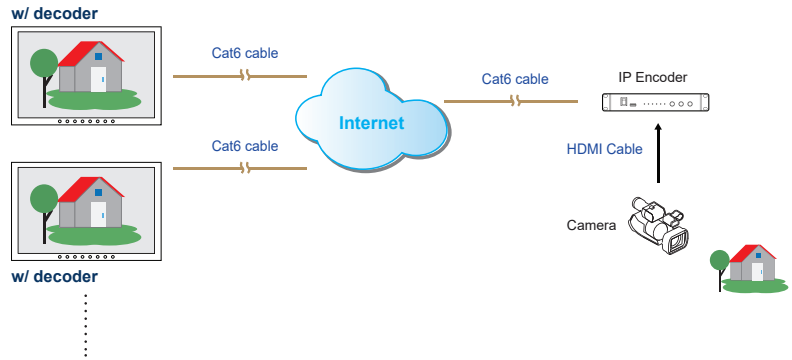

Part no.

Embedded HDMI Decoder Module : **UV-DE100F**
 Standalone HDMI Encoder : **UV-EN100F**

Embedded HDMI Receiver Module 1080p

- Extends the HDMI signal over a single Cat5/6 cable
- Supports video resolutions up to 1080p / 60Hz
- One to one just via Cat5/6 cable
- One to multi via network hub and Cat5/6 cable
- 100m maximum Cat5/6 cable distance
- Supports bi-directional IR communication
- High Speed HDMI 1.4 and HDCP 1.4 compliant
- No software or drivers required

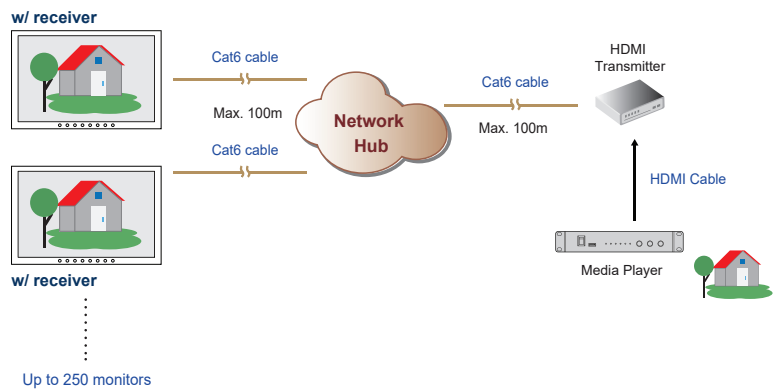

Part no.

Embedded HDMI Receiver Module : **UV-R100F**
 Standalone HDMI Transmitter : **UV-T100F**

Embedded HDMI Quad Display Module 1080p (For MF27 series only)

- Allows 4 x HDMI inputs to be monitored simultaneously
- Quad split, panel left and full screen monitoring modes
- High speed HDMI 1.4 and HDCP 1.4 compliant
- Supports video resolutions up to 1080p / 60Hz
- Supports Scaler Up and Down function
- Control via local front panel and IR remote

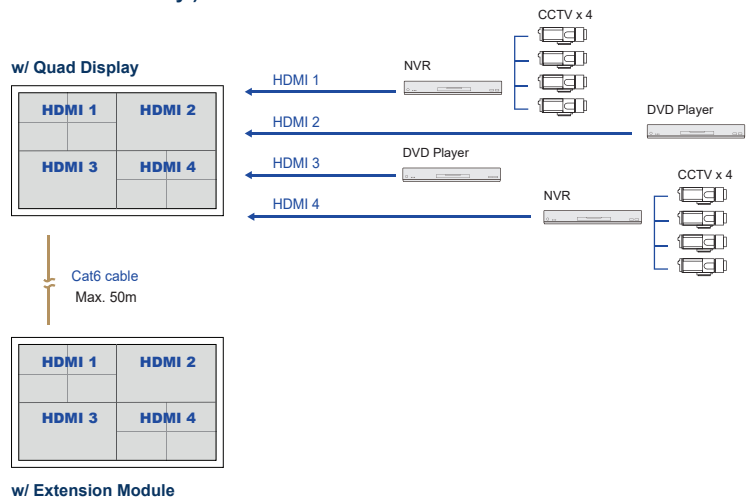

Part no.

Embedded HDMI Quad Display Module : **QD-1080**
 Embedded Quad Display Extension Module : **QD-E1080**

Options — Video Management & Transmission over Network

Embedded Multi Monitor OSD Control Module over serial

- Remote control the monitor OSD via RS-232C serial interface
- Daisy chain up to 64 monitors via Cat5/6 cable
- Individual ID for individual monitor OSD settings
- Power ON or OFF monitor
- Adjust brightness & audio
- Switch video sources

Up to 64 monitors
Up to 1,000m distance

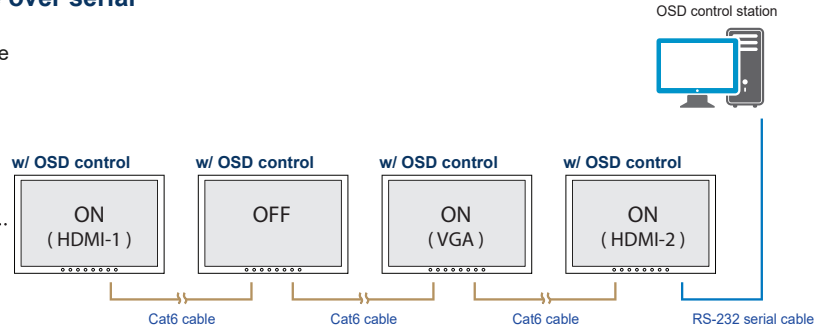

Part no.

Embedded Multi Monitor OSD Control Module : **MCS**

Embedded 3G / HD / SD-SDI Input Module

- Intelligent SDI monitoring with broadcast quality scopes
- Supports multi-rate 3G / HD / SD-SDI format
- Provides input to output loop-through capability
- Auto format sensing & selection

Part no.

Embedded 3G / HD / SD-SDI Input Module : **SDI**

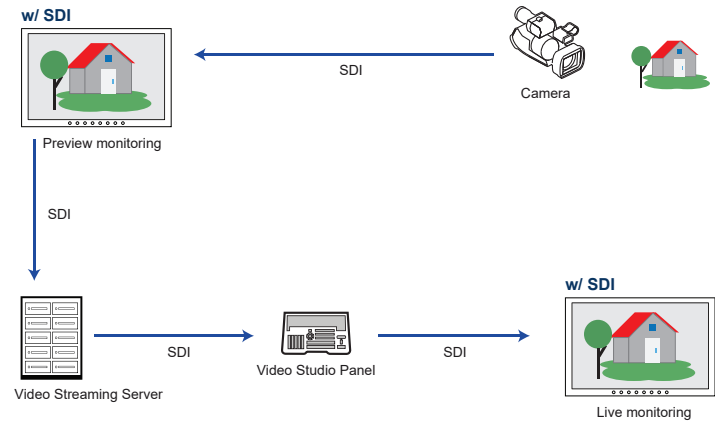

Embedded Portrait Mode Module (For MF27 series only)

- Provides users with a rotation feature (0, 90, 180 & 270 orientation) without frame delay via OSD
- Allows distortion-free display of content in various orientations
- Creates new application opportunities

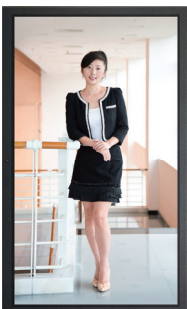

w/ Portrait mode module

Part no.

Embedded Portrait Mode Module : **AD4.0-P**

Embedded Auto Brightness Dimming Module

- Brightness changes according to its ambient brightness
- Its brightness change causes 10% increase or decrease

Part no.

Embedded Brightness Auto Dimming Module : **DA-01**

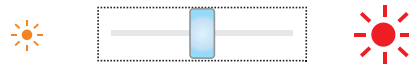

Embedded Manual Brightness Dimming Knob

- Easy-to-use IP54 dimming knob on the front panel
- One click causes 2% brightness increase or decrease
- Brightness adjustment from 0% to 100%

Part

Brightness Dimming Knob : **DS-01**

Product Specifications

LCD Panel	MF27
Panel size (diagonal)	27"
Native resolution	1920 x 1080
Brightness (cd/m ²)	400
Contrast ratio (typ.)	1000 : 1
Colors	16.7 M
Viewing angle (L/R/U/D)	85/85/80/80
Response time (ms)	5
Dot pitch (mm)	0.31125
Display area (mm)	597.6H x 336.15V
Surface treatment	Anti-glare
Surface hardness	3H
Backlight type	LED
MTBF (hrs)	30,000

Mounting	MF27
VESA mount (bundle)	100 x 100 mm
Universal mount (ready)	OP only
Overhead tilted wall-mount (optional)	AP / NAP / DP
Desktop stand (optional)	AP / NAP / DP
Panel mount (optional)	/

Power	MF27
Input	Auto-sensing 100 to 240VAC, 50 / 60Hz
Max. Consumption :	
Screen on	52W
Saving mode	9W
Button off	2W

Design	AP	NAP 	DP	OP
Protection	6mm front bezel	NEMA 4 / IP65	Front cover	Open frame
Front panel	Black, RAL 9005			-
Rear casing	Black, RAL 9005			

DVI-D / VGA input	
PC signal	1920 x 1080 x 60 / 144Hz 1440 x 900 x 60Hz 1360 x 768 x 60Hz 1280 x 1024 x 60 / 75Hz 1024 x 768 x 60 / 70 / 75Hz 800 x 600 x 60 / 72 / 75Hz 720 x 400 x 70Hz 640 x 480 x 60 / 72Hz
Audio signal	2ch Linear PCM

HDMI input	
PC signal	Same as VGA
HDMI 1.4	1920 x 1080 x 50 / 60Hz (1080p) 1920 x 1080 x 25 / 30Hz (1080i) 1280 x 720 x 50 / 60Hz (720p) 720 x 480 x 50 / 60Hz (576p / 480p)
Audio signal	2ch Linear PCM

Video	
VGA	Analog 0.7Vp-p
DVI	DVI-D single link
HDMI	HDMI 1.4 / HDCP 1.4

Audio Option	
Audio input :	
Connector	3.5mm stereo jack
Impedance / Power level	30kΩ / 750mV
Audio output :	
Connector	3.5mm stereo jack
Resistance / Power level	30kΩ / 2.8V
Speaker :	
Dual stereo speaker	2W x 2

* When the audio output is connected, speaker output is OFF

Product Specifications

Environment	
Operating temp.	0 to 55°C degree
Storage temp.	-20 to 60°C degree
Operating humidity	20~90%, non-condensing
Storage humidity	5 ~90%, non-condensing
Operating altitude	16,000 ft
Non-operating altitude	40,000 ft
Shock	10G acceleration (11ms duration)
Vibration	10~300Hz 0.5G RMS random

Compliance	
EMC	FCC & CE
Safety	CE / LVD & UKCA
Environment	RoHS3 & REACH

Physical Dimension & Weight

MF27”		AP-MF27	NAP-MF27	DP-MF27	OP-MF27
Product (W x D x H) :	mm	679 x 67.3 x 418.2		657.6 x 63.3 x 396.2	676.6 x 61.3 x 415.2
	inch	26.7 x 2.6 x 16.5		25.9 x 2.5 x 15.6	26.6 x 2.4 x 16.3
Net weight		16.8 kg / 37 lb	18.6 kg / 40.9 lb	14.8 kg / 32.6 lb	12.7 kg / 27.9 lb
Packing (W x D x H) :	mm	785 x 175 x 527			
	inch	30.9 x 6.9 x 20.7			
Gross weight		20.4 kg / 44.9 lb	22.2 kg / 48.8 lb	18.4 kg / 40.5 lb	16.3 kg / 35.9 lb

UltraView Family

UltraView series covers a full range of professional LCD display sizes. Please select from the below the most suitable model for your application.

[Sales Inquiry](#)

inquiry@austin-hughes.com

[Technical Support](#)

support@austin-hughes.com

4K

- K55"
- K43"
- K32"
- K28"
- K23"
- K17"
- K15"
- K13"

FHD

- F55"
- F43"
- F32"
- F28"
- F23"
- F21"
- F17"
- F15"
- F13"

FHD 144Hz

- MF27"

WXUGA (1920 x 1200)

- X24"
- X17"

Regular

- W19" (1440 x 900)
- 20" (1600 x 1200)
- 19" (1280 x 1024)
- 17" (1280 x 1024)
- 15" (1024 x 768)
- 12" (800 x 600)
- 10" (800 x 600)

High Brightness

4K

- K55"
- K43"

Sunlight Readable Brightness

FHD

- F55"
- F43"
- F32"
- F21"
- F17"
- F15"

Regular

- W19" (1440 x 900)
- 19" (1280 x 1024)
- 17" (1280 x 1024)

Americas

Austin Hughes Solutions Inc.
32900 Alvarado-Niles Rd, Suite 150
Union City, CA 94587
United States

inquiry@austin-hughes.com

EMEA

Austin Hughes Europe Ltd.
Unit 1, Chancery Gate Business Centre
Manor House Avenue
Southampton, SO15 0AE
United Kingdom

sales@austin-hughes.co.uk

APAC

Austin Hughes Electronics Ltd.
Unit 3608-12, Cable TV Tower
9 Hoi Shing Road, Tsuen Wan
Hong Kong

inquiry@austin-hughes.com

ASEAN

Austin Hughes Pte. Ltd.
3 Ang Mo Kio Street 62
#07-03 Link@AMK
Singapore 569139

inquiry@austin-hughes.com

Austin Hughes has an extensive distribution network, including the Americas, EMEA, APAC & ASEAN. Contact your nearest sales office for details of local representation.

Distributed by:

Distributor by country on application

Please ask for details of other products from Austin Hughes. Every effort has been made to ensure that the information contained herein is correct. There is a possibility that the image(s) shown may not be exactly the same as the final product. The company reserves the right to modify product specifications without prior notice and assumes no responsibility for any error which may appear in this publication.

All brand names, logo and registered trademarks are properties of their respective owners. Copyright 2022 Austin Hughes Electronics Ltd. All rights reserved.

CA-UV-621-MF-Q122V1