**LCM156-E/LCM170-E/
LCM215-E/LCM230-E/
LCM240-E Series
LCD Monitor**

User Manual

osee

Product Information

Model: LCM156-E/LCM170-E/LCM215-E/ LCM230-E/LCM240-E
Series LCD Monitor
Version: V010101
Release Date: November 11th, 2020

Company

OSEE TECHNOLOGY LTD.

Contact Information

OSEE TECHNOLOGY CO., LTD.

Address: No.22 Building, No.68 zone, Beiqing Road, Haidian District,
Beijing, China
Post Code: 100094
Tel: (+86) 010-62434168
Fax: (+86) 010-62434169
Web: <http://www.osee-dig.com/>
E-mail: sales@osee-dig.com

About this manual

Important

The following symbols are used in this manual:

Tips

- The further information or know-how for described subjects above which helps user to understand them better.
-

Warning

- The safety matters or operations that user must pay attention to when using this product.
-

Contents

The user manual applies to the following device types:

- **LCM156-E**
- **LCM170-E**
- **LCM215-E**
- **LCM230-E**
- **LCM240-E**

The images and descriptions of LCM156-E are adopted as examples in the following document. The basic features and functionalities for LCM156-E, LCM170-E and LCM230-E are almost as the same, any of the different specifications among the device types are elaborated.

Before reading the manual, please confirm the device type.

Contents

Contents	1
Chapter 1 Safety.....	1
Chapter 2 Unpack and Installation	5
Chapter 3 Locations and Function of Parts and Control.....	9
3.1 Front Panel	9
3.1.1 Location of Control Buttons	9
3.1.2 Function of Control Buttons	9
3.2 Rear Panel	13
3.3 Supported Signal Format	18
Chapter 4 Menu Operations	21
4.1 Main Menu.....	22
4.1.1 STATUS Menu	24
4.1.2 INPUT SELECT Menu	25
4.1.3 MARKER Menu	28
4.1.4 AUDIO Menu	32
4.1.5 DISPLAY Menu	36
4.1.6 CLOSED CAPTION Menu	40
4.1.7 CONFIG Menu.....	42
4.1.8 LOOK PROFILE Menu	49
4.1.9 FUNCTION KEY Menu	51
4.1.10 KEY INHIBIT Menu	56
4.2 Menu Settings.....	58
Chapter 5 Specifications	61
5.1 Product detailed information	61
5.2 Optional Accessories.....	63
5.3 Dimensions.....	73

Chapter 1 Safety

FCC Caution:

Any Changes or modifications not expressly approved by the party responsible for compliance could void the user's authority to operate the equipment.

This device complies with part 15 of the FCC Rules.

Operation is subject to the following two conditions: (1) This device may not cause harmful interference, and (2) this device must accept any interference received, including interference that may cause undesired operation.

Note: This equipment has been tested and found to comply with the limits for a Class B digital device, pursuant to part 15 of the FCC Rules. These limits are designed to provide reasonable protection against harmful interference in a residential installation. This equipment generates uses and can radiate radio frequency energy and, if not installed and used in accordance with the instructions, may cause harmful interference to radio communications. However, there is no guarantee that interference will not occur in a particular installation. If this equipment does cause harmful interference to radio or television reception, which can be determined by turning the equipment off and on, the user is encouraged to try to correct the interference by one or more of the following measures:

Reorient or relocate the receiving antenna.

Increase the separation between the equipment and receiver.

Connect the equipment into an outlet on a circuit different from that to which the receiver is connected.

Consult the dealer or an experienced radio/TV technician for help.

Warnings:

Read, keep and follow all of these instructions for your safety. Heed all warnings.

Warning

Device

- Install in accordance with the manufacturer's instructions.
- Do not beat with a hard object or scratch the LCD display.
- Do not make the freeze picture displaying on the screen time too long, otherwise, it will leave the afterimage on the screen.
- If the brightness is adjusted to the minimum, then it might be hard to see the display screen.
- Refer all servicing to qualified service personnel. Servicing is required if any of the following occurs:
 - The unit has been exposed to rain or moisture.
 - Liquid had been spilled or objects have fallen onto the unit.
 - The unit has been damaged in any way, such as when the power-supply cord or plug is damaged.
 - The unit does not operate normally, or has been dropped.
- Clean only with dry cloth.
- Do not block any ventilation openings. Leave enough space around the unit for ventilation.
- Do not use this unit near water.
- Do not use this unit near any heat sources such as radiators, heat registers, stoves, or other apparatus (including amplifiers) that product heat.
- A nameplate indicating operating voltage, etc., is located on the rear panel.
- The socket-outlet shall be installed near the equipment and shall be easily accessible.
- To reduce the risk of fire or electric shock, do not expose the unit to rain or moisture.
- To avoid electrical shock, do not open the cabinet. Refer all servicing to qualified service personnel.
- If the product needs replacement parts, make sure that the service person use replacement parts specified by the manufacture, or those with the same characteristics and performance as the original parts. Use of unauthorized parts can result in fire, electric shock and/or other damage.
- The panel used in this produce is made of glass. Therefore, it can break when it is dropped or applied with impact. Be careful not to be injured by broken glass pieces.

- Specifications are subject to change without notice.
-

Warning

- Do not use attachments or accessories not recommended by the manufacture. Use of inadequate attachments may result in serious accidents.
 - Do not overload AC outlet or extension cord. Overloading can cause fire or serious electric shock.
 - Do not defeat the safety purpose of the polarized or grounding-type plug.
 - Do not damage the power cord, place the heavy objects on the power cord, stretch the power cord, or bend the power cord.
 - Protect the power cord from being walked on or pinched, particularly at plugs, convenience receptacles, and the point where they exit from the unit.
 - If the power cord is damaged, turn off the power immediately. It is dangerous to use the unit with a damaged power cord. It may cause fire or electric shock.
 - Unplug this unit during lightning storms or when unused for long periods of time.
 - Disconnect the power cord from the AC outlet by grasping the plug, not by pulling the cord.
 - Should any solid object or liquid fall into the cabinet, unplug the unit and have it checked by qualified personnel before operating it any further.
-

Chapter 2 Unpack and Installation

Unpack:

When unpacking the LCM156-E monitor, please verify that none of the components listed in Table 3.1 are damaged or missing. If there are any components missing, please contact your distributors or OSEE for it.

Table 3-1 Packing List

No.	Item	Quantity
1	Device	1
2	Pedestal with screws	1
3	Power cord	1
4	Adapter	1
5	User manual	1

Installation:

1. Prepare for installation

Please follow the procedures below before installing LCM156-E:

- Check the package and equipment for any visible damage that may have occurred during transit.
- Confirm all the items listed on the packing list have been received.
- Remove all the packing material including electrostatic-resistant packing.
- Retain these packing materials for future use.

2. Install the LCM156-E in your desired method. Adequate ventilation is required when installed to prevent possible damage to the LCM156-E. (Note operational specifications are 40⁰ C (100⁰ F)).

There are screw holes at the rear panel of LCM-E series monitors, which are labeled in the following figures. Insert the pedestal into the case, and fasten it with the screws provided. The pedestal of LCM156-E(Optional), LCM170-E and LCM230-E are not quite the same. The pedestal installation for LCM215-E and LCM240-E are quite the same as LCM170-E's. Assemble the pedestal as follows.

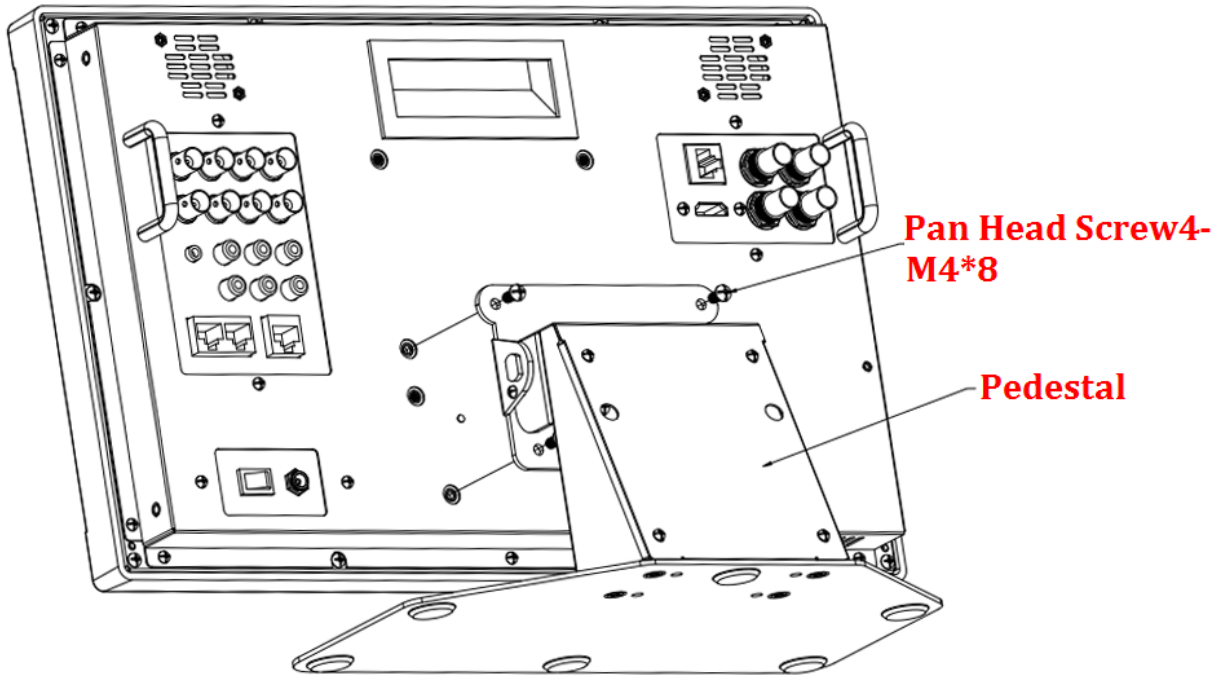

Figure 2-1 Assemble Pedestal of LCM156-E

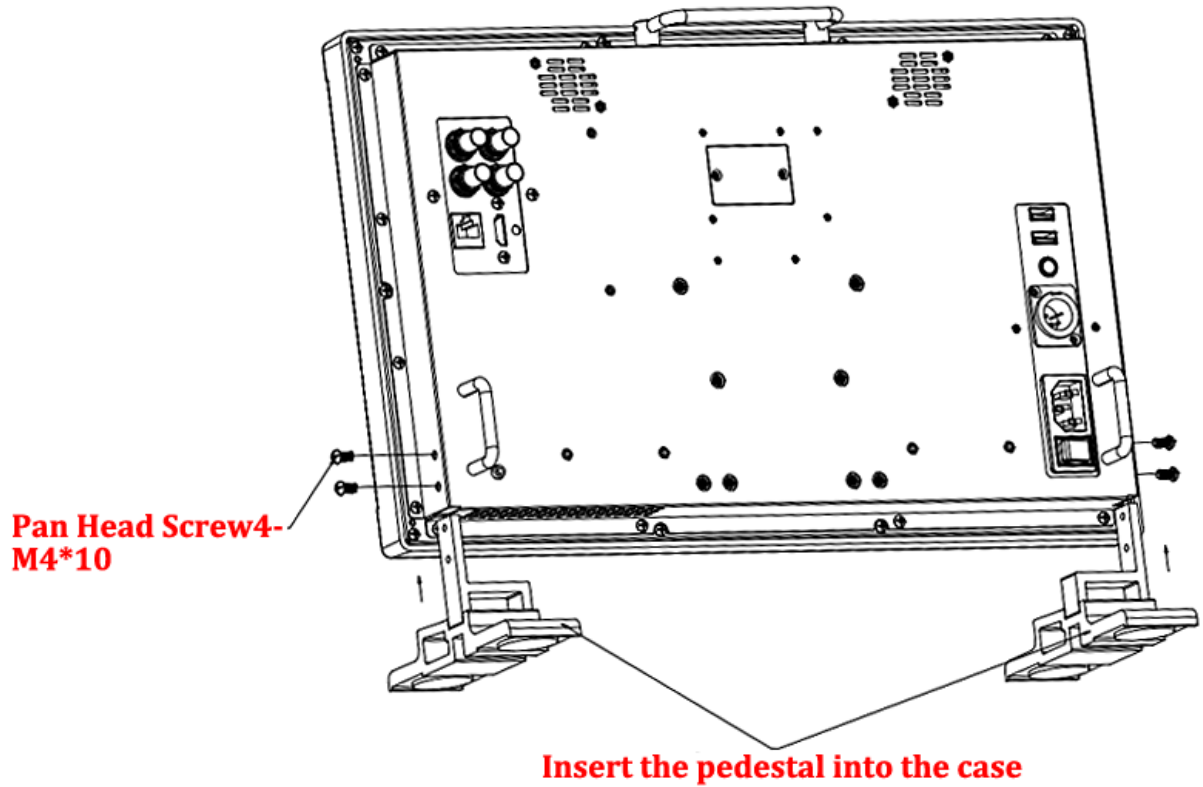

Figure 2-2 Assemble Pedestal of LCM170-E

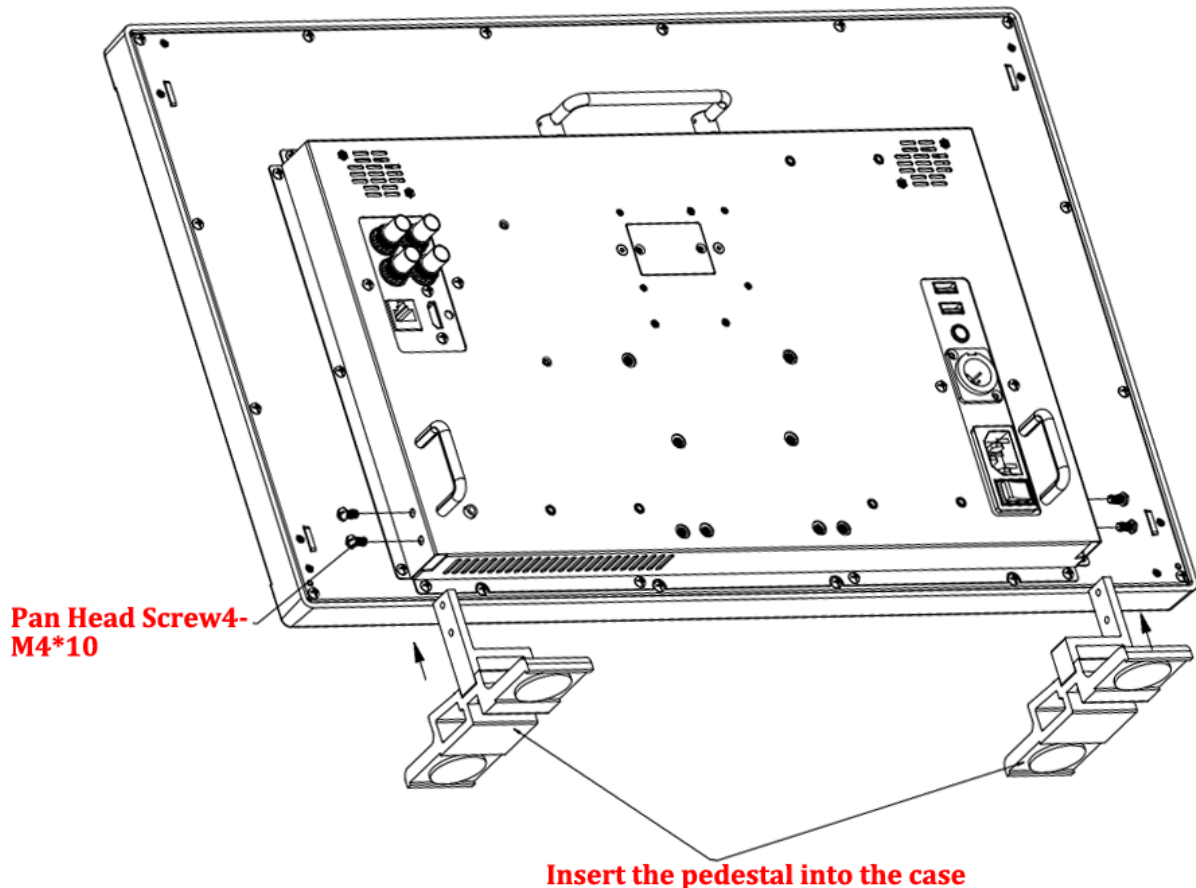

Figure 2-3 Assemble Pedestal of LCM230-E

3. Connect required cables for signal input and output. For BNC connections use 75Ω rated connectors.
4. Connect the power source using the included power supply or optional battery adapter and D-Tap to Power cable when not using Land Line power.
5. As a final step, turn on the device by toggling the power switch located on the rear of the unit near the power jack.

Tips

- Connect a standard signal line to the corresponding input port.
- Please use the power adapter supplied for AC power.
- The factory default value for IP address is 192.168.1.86.

Chapter 3 Locations and Function of Parts and Control

3.1 Front Panel

3.1.1 Location of Control Buttons

The control buttons are at the bottom of the screen, as shown in Figure 3.1-1.

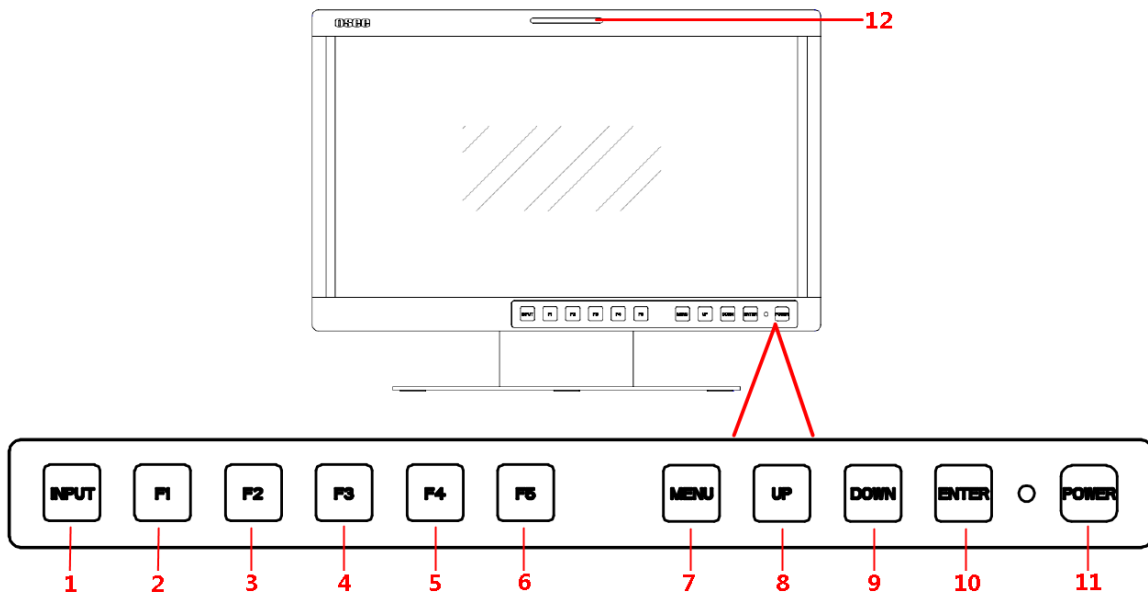

Figure 3.1-1 Buttons in Front Panel

- | | |
|---|--|
| 1. INPUT: Input selection button | 8. UP: Menu operation button |
| 2. F1: Function button | 9. DOWN: Menu operation button |
| 3. F2: Function button | 10. ENTER: Menu operation button |
| 4. F3: Function button | 11. POWER/Lamp |
| 5. F4: Function button | 12. TALLY: TALLY indicator(LED TALLY) |
| 6. F5: Function button | |
| 7. MENU: Menu operation button | |

3.1.2 Function of Control Buttons

INPUT Selection Button

Press **INPUT** button and toggle or use the **UP/DOWN** button to select and display the corresponding signal input to each connector.

- **SDI1**: monitor the **SDI** input as the active signal through the **SDI1 IN** connector.
- **SDI2**: monitor the **SDI** input as the active signal through the **SDI2 IN** connector.
- **LINE1(CVBS)**: monitor the **Composite Analog Input** as the active signal through the **LINE1 IN** connector.
- **LINE2(CVBS)**: monitor the **Composite Analog Input** as the active signal through the **LINE2 IN** connector.
- **LINE2(Y/C)**: monitor the **Composite Analog Input** as the active signal through the **Y IN** connector and **C IN** connector.
- **LINE2(YPBPR)**: monitor the **Composite Analog Input** as the active signal through the **Y IN** connector, **Pb IN** connector and **Pr IN** connector.
- **HDMI**: monitor the **HDMI** or **DVI** input as the active signal through the **HDMI IN** connector.

When switching an input source, it will display the SOURCE menu at the right top corner of the screen, and the current active source is labeled in highlight yellow, as shown in Figure 3.1-2.

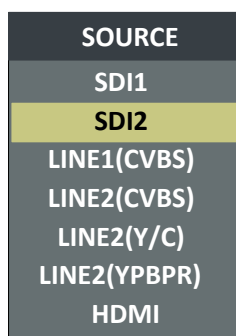

Figure 3.1-2 Source Menu

Tips

- Particularly, in PIP/PBP display mode, the signal source for the main picture is set by INPUT button, while the slave picture's is set through the CONFIG→SUB IN SELECT item in main menu, refer to “4.1.7 CONFIG Menu” for the details.

Function Buttons

F1~F5 button are all function buttons. Pressing any F button will display the assigned Functions. Pressing the desired function will select the function. When selected, the Function will then toggle through the desired setting including OFF.

The function of each button can be set via the **FUNCTION KEY** setting in the main

menu.

OPERATION: for example, press **F1** to display the **FUNCTION** menu at the left bottom corner of the screen, as shown in Figure 3.1-3. Toggle **F1** button to change the value related to this function without the setting value display.

FUNCTION		
F1	FLASE COLOR	ON
F2	NATIVE	OFF
F3	MONO	OFF
F4	FREEZE	OFF
F5	PBP	OFF

Figure 3.1-3 Function Menu

Tips

- The **FUNCTION** menu will be closed automatically ten seconds after the last button push.
- You can assign various functions to each F1~F5 button through **FUNCTION KEY** menu. Refer to "4.1.9 FUNCTION KEY Menu" for the details.

FACTORY RESET Function.

Press and hold the **INPUT+F2** button for 3 seconds to access the menu in Figure 3.1-4.

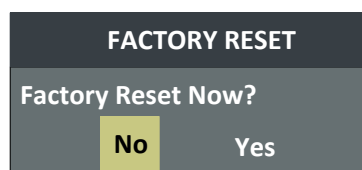

Figure 3.1-4 Reset Menu

Menu Operation Buttons

Display or set the MAIN menu.

■ MENU Button

Used to activate MAIN menu.

- Press to display the MAIN menu
- Press again to clear the MAIN menu

■ **UP**

Used to navigate on-screen menu.

Toggle this button to select the previous item or increase the item value.

■ **DOWN**

Used to navigate on-screen menu.

Toggle this button to select the next item or decrease the item value.

■ **ENTER**

Used to navigate on-screen menu, confirm selection with the MAIN menu, or load the Adjust menu.

MENU Selection and Setting

When displaying the MAIN menu, press **ENTER** button to select a menu item or setting value, the active item is labeled in a highlight color, then press **ENTER** button to confirm the settings, otherwise, press **MENU** button to give up the modification and turn back the higher level menu item.

Refer to “4.2 Menu Settings” for detail about the MAIN Menu operations.

Adjust Menu-Adjust VOLUME, BRIGHTNESS, CONTRAST, CHROMA

When not displaying the MAIN menu, press **ENTER** button to display the **Adjust** menu, as shown in Figure 3.1-5.

Toggle among these adjustable items: VOLUME, BRIGHTNESS, CONTRAST, CHROMA.



Figure 3.1-5 Adjust Menu

After displaying the Adjust menu, press **UP** or **DOWN** button to adjust the item value, and then press **ENTER** button to confirm the value setting. The relationship of the items and their range is list in Table 3.1-1:

Table 3.1-1 The Description of Adjust Menu Items

Adjust Menu	Description	Range	Default
VOLUME	Adjust the volume	0~31dB	16
BRIGHTNESS	Adjust the image brightness	0~100	50
CONTRAST	Adjust the image contrast	0~100	50
CHROMA	Adjust the image monochroma	0~100	50

i Tips

- The **Adjust** menu will be closed automatically ten seconds after the last button

push.

Power Button and Indicator

Used to turn the power to place the monitor into standby mode/off.

When the device is off(Red), press the **POWER** button to turn it on. The power indicator lights in green.

Flashing green indicates no signal is present (refer to section 3.1.1)

When the device is on, press the **POWER** button to turn it off. The power indicator lights in red.

3.2 Rear Panel

For the arrangement of the rear panel of LCM170-E and LCM230-E are the same, which are different from the LCM156-E's.

The rear panel of LCM156-E is shown as below, there are various input and output interfaces at the rear panel of LCM156-E monitor.

Parts and Functions

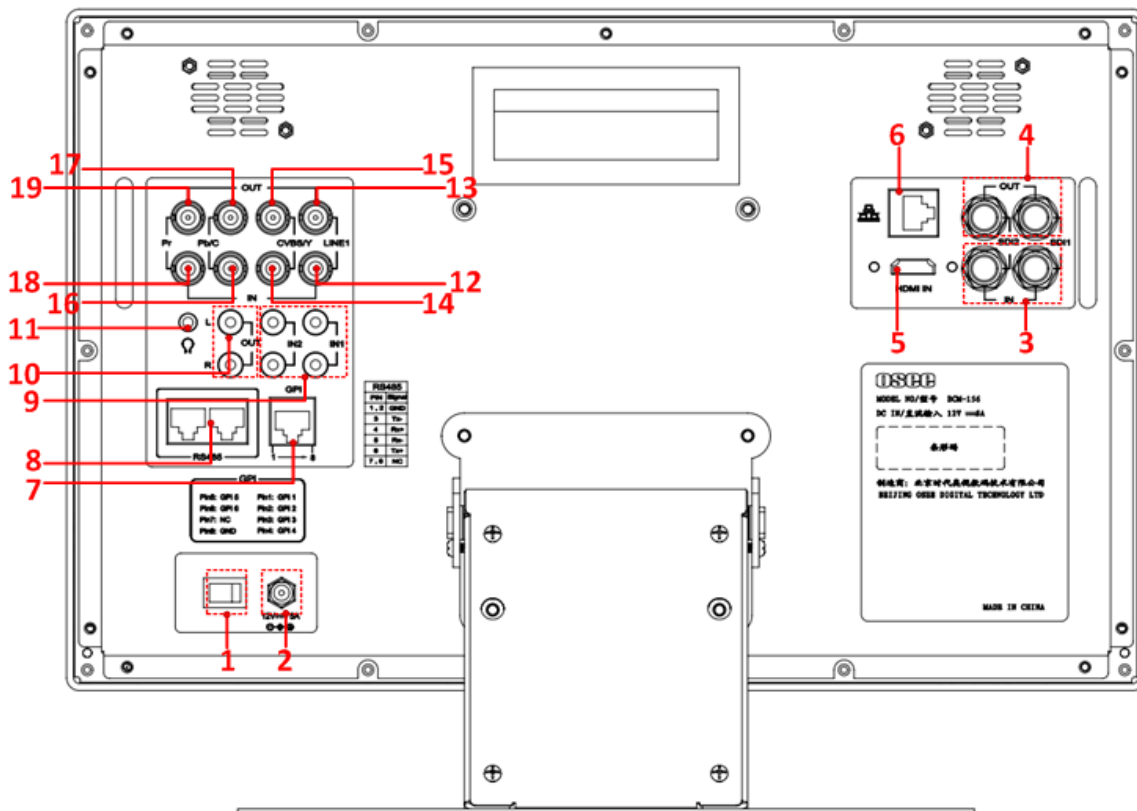

Figure 3.2-1 The Rear Panel of LCM156-E Monitor

The interfaces numbered from 1 to 19 in red dotted rectangle are described as

follows:

1. Power Switch

Press this part to switch on or switch off the power.

Push the button to the “-” icon to switch on the power.

Push the button to the “O” icon to switch off the power.

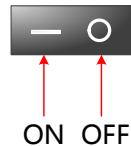

2. Power Input

Plug the power supply to this interface to provide power to the device.

The specification is 12V5ADC.

3. SDI1 IN, SDI2 IN(BNC)

Two SDI signal input interfaces, support multiple format HD/3G-SDI inputs.

4. SDI1 OUT, SDI2 OUT(BNC)

Two SDI signal output interfaces.

5. HDMI IN(HDMI)

One HDMI signal input interface, HDMI Type-A connector, support HDMI or DVI signal.

6. Ethernet(RJ-45)

A 10/100M Ethernet interface. Provide connection to a computer for external control.

7. GPI interface(RJ-45)

Reserved and not defined.

8. RS485 (RJ-45)

Reserved and not defined.

9. Line IN(Unbalanced signal RCA connector)

Two pairs of analog audio stereo input interfaces: AUDIO IN1 L, AUDIO IN1 R, AUDIO IN2 L, AUDIO IN2 R.

Connect to the audio outputs of external device.

10. L OUT, R OUT(RCA)Audio Output

Two audio output interfaces: AUDIO OUTPUT L, AUDIO OUTPUT R.

Output the analog stereo signal. The output audio can be changed in **AUDIO** settings.

11. Headphone Output Connector (3.5mm stereo Jack)

12. LINE1 IN

A composite analog video input interface.

13. LINE1 OUT

A composite analog video output interface.

14. LINE2(CVBS/Y) IN

A composite analog video input interface.

Feed the composited LINE2, or component Y signal.

15. LINE2(CVBS/Y) OUT

A composite analog video output interface.

Output the composited LINE2, or component Y signal.

16. LINE2(Pb/C) IN

A component analog video input interface.

Feed the component Pb, or component C signal.

17. LINE2(Pb/C) OUT

A component analog video output interface.

Output the component Pb, or component C signal.

18. LINE2(Pr) IN

A component analog video input interface.

Feed the component Pr signal.

19. LINE2(Pr) OUT

A component analog video output interface.

Output the component Pr signal.

INPUT/OUTPUT VIDEO Connection Method

It provides two pairs of Composited Video input/output interfaces(LINE1, LINE2), and a group of component signals(YPbPr, Y/C), the Y/C signal is also called as S-Video. It will transmit different component signal according to the corresponding signal interfaces.

As shown in Figure 3.2-2, the relationship of the signal sources and the interfaces are shown as in Table 3.2-1:

Table 3.2-1 The Relationship of the Signal Sources and Input/output Interfaces

Signal Source	Video Input Interfaces	Video Output Interfaces
LINE1	LINE1 IN	LINE1 OUT
LINE2(CVBS)	LINE2(CVBS/Y) IN	LINE2(CVBS/Y) OUT
LINE2(Y/C)	LINE2(CVBS/Y) IN LINE2(Pb/C) IN	LINE2(CVBS/Y) OUT LINE2(Pb/C) OUT
LINE2(YPBPR)	LINE2(CVBS/Y) IN LINE2(Pb/C) IN LINE2(Pr) IN	LINE2(CVBS/Y) OUT LINE2(Pb/C) OUT LINE2(Pr) OUT

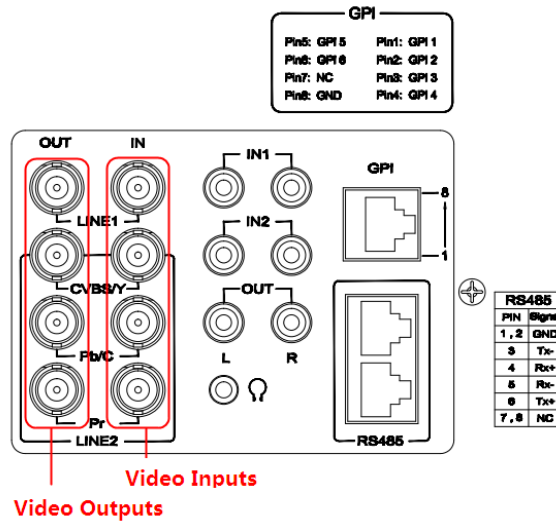

Figure 3.2-2 Video Input/Output Interfaces

The real panel of LCM170-E is as same as the LCM230-E's, as shown below:

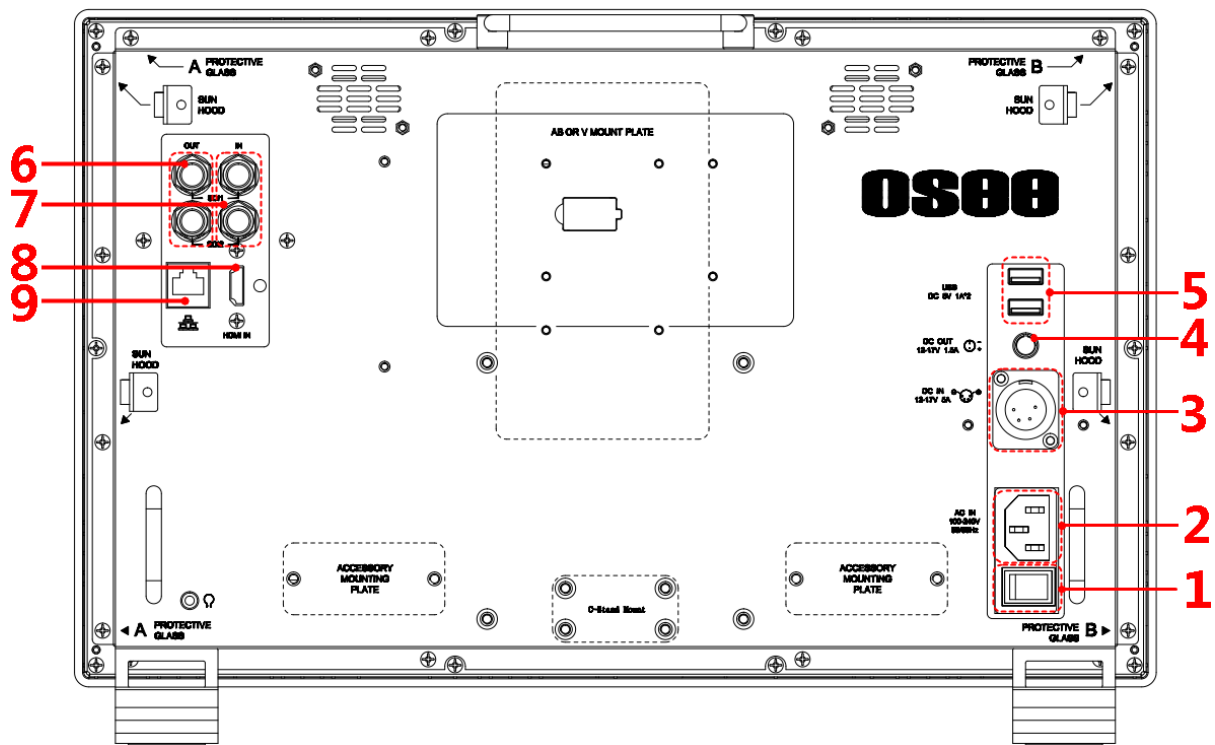

Figure 3.2-3 The Rear Panel of LCM170-E Monitor

1. Power Switch

Press this part to switch on or switch off the power.

Push the button to the “-” icon to switch on the power.

Push the button to the “O” icon to switch off the power.

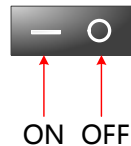

2. Power Input-AC IN

Plug the power supply to this interface to provide power to the device.

The specification is 100~240V 50/60Hz AC.

3. Power Input- DC IN 14.5V

One DC input interface from battery powered, 14.5V DC.

4. Power Output-DC OUT 12V/BATT 1.5A

One DC output interface, 1.5A DC. This interface provides a LEMO two core socket of 1.5A current limit. When using AC power supply, the output voltage is 12V, and when using battery powered, the output voltage is consistent with the output voltage of battery.

5. Power Output-DC OUT 5V 1AX2

Two DC output interfaces, 5V1A DC.

Tips

- The **two DC OUT interfaces** only provide power supply of 1A current limit, without data communication service.

Warning

- Particularly for LCM215-E, the DC outputs including the LEMO output(DC OUT 12V/BATT 1.5A) and the two USB outputs(DC OUT 5V 1A) are only available when using the DC input(DC IN 14.5V) as the unit power supply interface !

6. SDI1 IN, SDI2 IN(BNC)

Two SDI signal input interfaces, support multiple format HD/3G-SDI inputs.

7. SDI1 OUT, SDI2 OUT(BNC)

Two SDI signal output interfaces.

8. HDMI IN(HDMI)

One HDMI signal input interface, HDMI Type-A connector, support HDMI or DVI signal.

9. Ethernet(RJ-45)

A 10/100M Ethernet interface. Provide connection to a computer for external control.

Warning

- Only use the adapter and the power cord specified by the manufacture for your safety!

3.3 Supported Signal Format

The supported signal format for this device is as shown in Table 3.3-1:

Table 3.3-1 Supported Signal Format

	SDI	VIDEO ¹	HDMI	YC	YPBPR
PAL		<input type="radio"/>		<input type="radio"/>	
NTSC		<input type="radio"/>		<input type="radio"/>	
720P24/23.98	<input type="radio"/>				<input type="radio"/>
720P25	<input type="radio"/>		<input type="radio"/>		<input type="radio"/>
720P30/29.97	<input type="radio"/>		<input type="radio"/>		<input type="radio"/>
720P50	<input type="radio"/>		<input type="radio"/>		<input type="radio"/>
720P60/59.94	<input type="radio"/>		<input type="radio"/>		<input type="radio"/>
1080SF24/23.98	<input type="radio"/>		<input type="radio"/>		<input type="radio"/>
1035I60/59.94	<input type="radio"/>		<input type="radio"/>		<input type="radio"/>
1080I50	<input type="radio"/>		<input type="radio"/>		<input type="radio"/>
1080I60/59.94	<input type="radio"/>		<input type="radio"/>		<input type="radio"/>
1080P24/23.98	<input type="radio"/>		<input type="radio"/>		<input type="radio"/>
1080P25	<input type="radio"/>		<input type="radio"/>		<input type="radio"/>
1080P30/29.97	<input type="radio"/>		<input type="radio"/>		<input type="radio"/>
1080P50	<input type="radio"/>		<input type="radio"/>		<input type="radio"/>
1080P60/59.94	<input type="radio"/>		<input type="radio"/>		<input type="radio"/>
2048X1080PSF24/23.98	<input type="radio"/>				

¹ VIDEO: The VIDEO in the head of this table is refer to CVBS signal, that is, the signal through the LINE1(CVBS) or LINE2(CVBS) interface.

	SDI	VIDEO ¹	HDMI	YC	YPBPR
2048X1080PSF25	○				
2048X1080PSF30/29.97	○				
2048X1080P24/23.98	○		○		
2048X1080P25	○		○		
2048X1080P30/29.97	○		○		
2048X1080P48/47.94	○		○		
2048X1080P50	○		○		
2048X1080P60/59.94	○		○		
VGA(640X480)			○		
SVGA(800X600)			○		
XGA(1024X768)			○		
SXGA(1280X1024)			○		
WXGA(1360X768)			○		
WXGA+(1440X900)			○		
WXGA+(1400X1050)			○		
UXGA(1600X1200)			○		
UXGA+(1680X1050)			○		
WUXGA(1920X1080)			○		
WUXGA(1920X1200)			○		

Tips

- LCM170-E, LCM215-E, LCM230-E and LCM240-E only support SDI and HDMI.

Chapter 4 Menu Operations

This chapter describes the structure and functionality of the On-Screen Menu, and introduces how to modify and customize the menu settings.

The Main Menu consists of the following sections: **STATUS**, **INPUT SELECT**, **MARKER**, **AUDIO**, **DISPLAY**, **CLOSED CAPTION**, **CONFIG**, **LOOK PROFILE**, **FUNCTION KEY** and **KEY INHIBIT**, as shown in Figure5-1.



Figure 5-1 On-Screen Menu

The features on the screen are as shown in Figure 5-2:

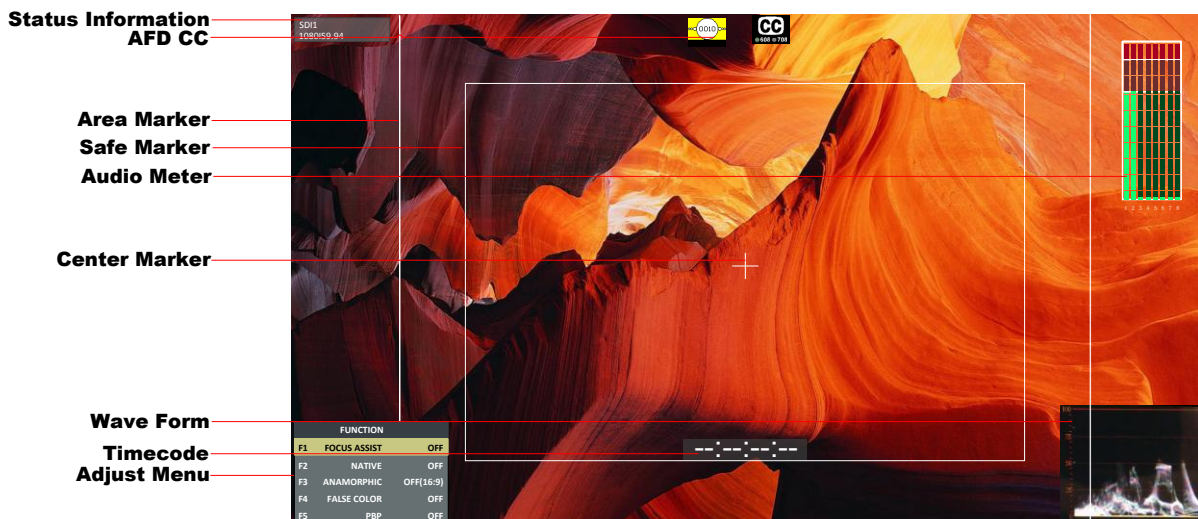

Figure 5-2 Features of LCM156-E Monitor

Status Information: it displays the input channel and signal format. Set by DISPLAY→ Status Display item.

AFD Information: Set by DISPLAY→ AFD Display item.

CC Information: Set by CLOSED CAPTION menu.

Marker Information: including Area Marker, Center Marker and Safety Maker, and set by Marker menu.

Audio Meter: Set by Audio menu.

Wave Form: Set by DISPLAY menu.

Time Code: Set by DISPLAY menu.

FUNCTION Menu: it will pop up when pressing the F1~F5 button, and set by FUNCTION menu.

Please refer to the corresponding sections for the details in this chapter.

4.1 Main Menu

Display the Main Menu

Press the **MENU** button to display the Main Menu at the top left corner of the screen, as shown in Figure 4.1-1:

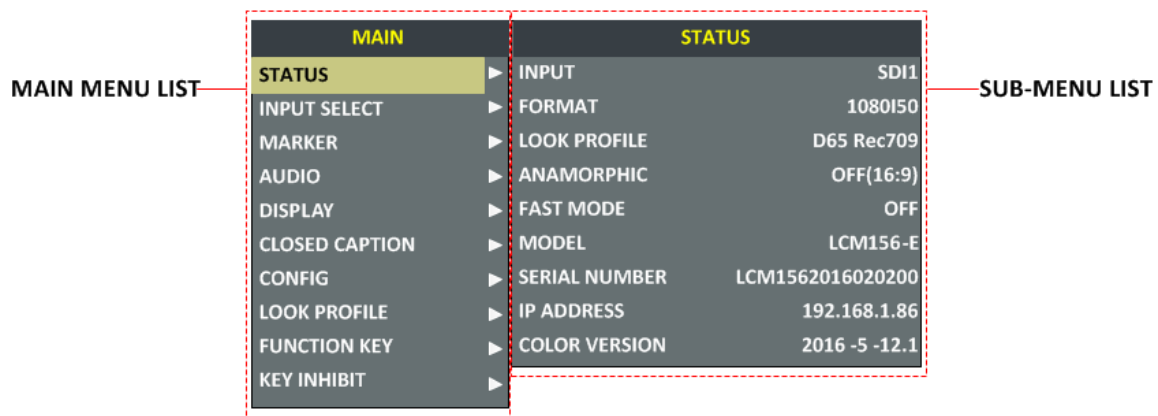

Figure 4.1-1 the Structure of the Main Menu

The menu interface is divided into two parts: Main Menu List and Sub-menu list.

Menu Control

You may control these various functions using **MENU**, **UP**, **DOWN** and **ENTER** buttons. Follow the instructions below:

Press **UP** or **DOWN** to navigate to a menu item, then, press **Enter** button to enter into the sub-menu list of the selected item.

1. Press **MENU** button to display the MAIN Menu.
2. Press **UP** or **DOWN** button to move the control icon to your target menu item in main menu list, here, the control icon is a highlight yellow rectangle which is used to label the current active selection.
3. Press **Enter** button to access the sub-menu list of the selected main menu,

and press **UP** or **DOWN** button again to select your target sub-menu item which you want to modify its value.

4. Press **Enter** button to confirm the selection of your target sub-menu item, and press **UP** or **DOWN** button to adjust its value from its sub-menu item list.

5. Press **Enter** button to save the value, otherwise, press **Menu** button to give up the modification or selection, and return to the previous menu, and if there is no previous menu, it will clear the MAIN Menu.

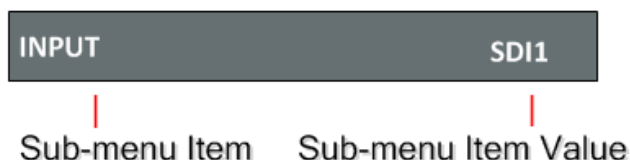

Figure 4.1-2 the Sub-menu Value List

i Tips

- The control icon is displayed as a highlight yellow rectangle at the background of the current active item.
- The item displayed in blue can't be accessed currently. You can access the item which is displayed in white except the STATUS settings.

For example: choose the **INPUT SELECT**→**SDI1** item, the control icon is displayed as shown in Figure 4.1-3:

MAIN	INPUT SELECT	
STATUS	▶ SDI1	ON
INPUT SELECT	▶ SDI2	ON
MARKER	▶ LINE1	OFF
AUDIO	▶ LINE2	OFF
DISPLAY	▶ HDMI	ON
CLOSED CAPTION	▶ NTSC SETUP	7.5
CONFIG	▶ NTSC PHASE	0
LOOK PROFILE	▶ FOCUS ASSIST	OFF
FUNCTION KEY	▶ FOCUS LEVEL	50
KEY INHIBIT	▶ FOCUS COLOR	RED
	ZEBRA	OFF
	ZEBRA LEVEL	50

Figure 4.1-3 A Sub-menu Item Is Selected

Tips

- If the **KEY INHIBIT**→**KEY INHIBIT** is set to be **ON**, all items will not be displayed except **KEY INHIBIT** item. To change any one of the items, you should turn the **KEY INHIBIT**→**KEY INHIBIT** to be OFF first. Refer to "4.1.10 KEY INHIBIT Menu" for the details.

The following will introduce the contents and functionality of these menu items in sorts.

4.1.1 STATUS Menu

The **STATUS** menu items are not configurable settings, but provide important information of the monitor, such as input signal resolution and frame rate, active color space, model, serial number, and IP Address, etc.

Press **MENU** button to display the Main Menu, and the **STATUS** menu items are as shown in Figure 4.1-4:

MAIN	STATUS
STATUS	▶ INPUT SDI1
INPUT SELECT	▶ FORMAT 1080I50
MARKER	▶ LOOK PROFILE D65 Rec709
AUDIO	▶ ANAMORPHIC OFF(16:9)
DISPLAY	▶ FAST MODE OFF
CLOSED CAPTION	▶ MODEL LCM156-E
CONFIG	▶ SERIAL NUMBER LCM1562016020200
LOOK PROFILE	▶ IP ADDRESS 192.168.1.86
FUNCTION KEY	▶ COLOR VERSION 2016 -5 -12.1
KEY INHIBIT	▶

Figure 4.1-4 STATUS Menu

The relationship of Items, Default Value, Domain Range and Description of the sub-item is as shown in Table 4.1-1:

Table 4.1-1 The Description of STATUS Menu Items

Items	Default Value	Description
INPUT	SDI1	Show the current Input interface
FORMAT	1080I50	Show the signal resolution and frame rate of the current input

Items	Default Value	Description
LOOK PROFILE	D65 Rec709	Show the LOOK PROFILE Feature.
ANAMORPHIC	16:9	Show the aspect ratio of the picture.
FAST MODE	OFF	Show the fast mode.
MODEL	LCM156-E	Show the production model.
SERIAL NUMBER	LCM1562016020200	Show the serial number.
IP ADDRESS	192.168.1.86	Show the IP address.
COLOR VERSION	2016-5-12.1	Show the color version according to its adjusted date.

4.1.2 INPUT SELECT Menu

The INPUT SELECT menu items are used to enable the input signals, NTSC level and phase, FOCUS settings and ZEBRA settings, as shown in Figure 4.1-5:

MAIN	INPUT SELECT	
STATUS	SDI1	ON
INPUT SELECT	SDI2	ON
MARKER	LINE1	OFF
AUDIO	LINE2	OFF
DISPLAY	HDMI	ON
CLOSED CAPTION	NTSC SETUP	7.5
CONFIG	NTSC PHASE	0
LOOK PROFILE	FOCUS ASSIST	OFF
FUNCTION KEY	FOCUS LEVEL	50
KEY INHIBIT	FOCUS COLOR	RED
	ZEBRA	OFF
	ZEBRA LEVEL	50

Figure 4.1-5 INPUT SELECT Menu

The relationship of Items, Default Value, Domain Range and Description of the sub-item is as shown in Table 4.1-2:

Table 4.1-2 The Description of INPUT SELECT Menu Items

Items	Default Value	Domain Range	Description
SDI1	ON	ON/OFF	Enable/Disable SDI1 input.
SDI2	ON	ON/OFF	Enable/Disable SDI2 input.

Items	Default Value	Domain Range	Description
LINE1	OFF	ON/OFF	Enable/Disable LINE1 input.
LINE2	OFF	<ul style="list-style-type: none"> • CVBS • LINE2(Y/C) • LINE2(YPBPR) • OFF 	Enable/Disable LINE2 input, and select the input source format.
HDMI	ON	ON/OFF	Enable/Disable HDMI input.
NTSC SETUP	7.5	<ul style="list-style-type: none"> • 0: the 0 setup level is used mainly in Japan. • 7.5: the 7.5 setup level is used mainly in North America. 	Set the black level of NTSC video to 0 setup or 7.5 IRE setup.
NTSC PHASE	0	-50~50	Set the NTSC phase level, and this item is available only when NTSC format signal is input.
FOCUS ASSIST	OFF	<ul style="list-style-type: none"> • OFF • GRAY: Turn the image into gray mode, and displays the edge of images with color selected in FOCUS COLOR. • COLOR: Displays the edge of images with color selected in FOCUS COLOR. 	Enable/Disable the focus assist function, and set focus assist mode. When the difference of the edges exceeds the reference value (FOCUS LEVEL), the edge detected will be in colorful feature set by FOCUS COLOR.
FOCUS LEVEL	50	0~100	Set the edge difference value between the edges in an image, and take this value as the reference value. Larger value means more detail detection.
FOCUS COLOR	RED	RED/GREEN/BLUE	Set the color for the detected edge of images.
ZEBRA	OFF	ON/OFF	Enable/Disable the zebra function that will compare the signal luminance with the ZEBRA LEVEL , and fill the relevant image area whose luminance is higher than the ZEBRA LEVEL with a zebra pattern.

Items	Default Value	Domain Range	Description
ZEBRA LEVEL	50	0~100	Set the reference level of detecting luminance.

FOCUS ASSIST

The FOCUS ASSIST function is used to display images on the screen with intensified edge to help camera focus operation. The intensified edges are those areas whose difference value exceeds the reference focus level (**FOCUS LEVEL**), and the intensified edge are displayed in the designated color set by **FOCUS COLOR**.

For example, set the **FOCUS LEVEL** as 80, the compared results between **COLOR** mode and **GRAY** mode are as shown **Figure 4.1-6**, the intensified edges are in the designated color.



Figure 4.1-6 Illustration for FOCUS ASSIST Function

ZEBRA

The ZEBRA function is used to display images on the screen with a zebra pattern to adjust the camera exposure parameter. It will compare the signal luminance with the **ZEBRA LEVEL**, and fill the relevant image area whose luminance is higher than the **ZEBRA LEVEL** with a zebra pattern.

For example, set the **ZEBRA LEVEL** as 80, the compared results are as shown in **Figure 4.1-7**, the special area is filled with a zebra pattern.



Figure 4.1-7 Illustration for LUMA ZOOM CHECK Function

LINE2

Select input source format for LINE2 among **LINE2(CVBS)**, **LINE2(Y/C)** and **LINE2(YPBPR)**.

For LINE2(CVBS) interface, LINE2(Y/C) interface and LINE2(YPbPr) interface share the same group of physical interfaces, select the signal source format for LINE2 according to the cable connection mode.

To select a signal source format for LINE2, you can set the menu item **INPUT SELECT**→**LINE2** to be **LINE2(CVBS)**, **LINE2(Y/C)** or **LINE2(YPBPR)**, in addition, press **INPUT** button to pop up the **SOURCE MENU** for LINE2 selection.

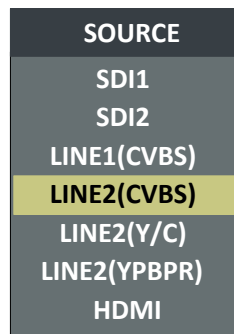

Figure 4.1-8 LINE2 SWITCHING in SOURCE MENU

Tips

- **NTSC PHASE** item is available only when NTSC format signal is input, while, only the LINE1 and LINE2 (CVBS) interface support NTSC format signal.

4.1.3 MARKER Menu

The **MARKER** menu items are used to display various markers and set the marker preference. It provides **Area Marker**, **Center Marker**, **Safety Marker** and **Cross Hatch**, while, you can set the aspect ratio of safety area, the darkness outside of the safety area, etc. These markers can be flexibly controlled by the following settings, as shown in Figure 4.1-9:

MAIN		MARKER	
STATUS	▶	MARKER	OFF
INPUT SELECT	▶	AREA MARKER	OFF
MARKER	▶	CENTER MARKER	OFF
AUDIO	▶	SAFETY MARKER	OFF
DISPLAY	▶	MARKER LEVEL	1
CLOSED CAPTION	▶	MARKER MAT	OFF
CONFIG	▶	CROSS HATCH	OFF
LOOK PROFILE	▶		
FUNCTION KEY	▶		
KEY INHIBIT	▶		

Figure 4.1-9 MARKER Menu

The relationship of Items, Default Value, Domain Range and Description of the sub-item is as shown in Table 4.1-3:

Table 4.1-3 The Description of MARKER Menu Items

Items	Default Value	Domain Range	Description
MARKER	OFF	OFF/ON	Set ON to display the markers and OFF not to display. It is the master switch for Area Marker, Center Marker and Safety Marker.
AREA MARKER	OFF	When the display aspect is 16:9, select the following aspect ratio: <ul style="list-style-type: none"> • OFF: close area marker • 4:3 • 15:9 • 14:9 • 13:9 • 1.85:1 • 2.35:1 When the display aspect is 4:3, select the following aspect ratio: <ul style="list-style-type: none"> • OFF: close area marker • 16:9 	Select the aspect ratio of the Area Marker.
CENTER	OFF	OFF/ON	Set whether to display a cross

Items	Default Value	Domain Range	Description
MARKER			marker which represents the center of the image.
SAFETY MARKER	OFF	<ul style="list-style-type: none"> • OFF • 80% • 85% • 88% • 90% • 93% • 95% 	Select to display and control the size of the safety area, that is, the effective screen area.
MARKER LEVEL	1	<ul style="list-style-type: none"> • 1: 50% • 2: 75% • 3: 100% 	Set the luminance to display Safety Marker, Center Marker, Area Marker and Cross Hatch.
MARKER MAT	OFF	<ul style="list-style-type: none"> • OFF: Normal background, use line for area marker edge only • HALF: 50% Background darkness • BLACK: all black 	Set the darkness degree of the mat area. This item darkens the area of the outside of marking area.
CROSS HATCH	OFF	OFF/ON	Set whether to show the cross hatch.

MARKERS

CENTER MARKER, AREA MARKER, SAFETY MARKER, CROSS HATCH.

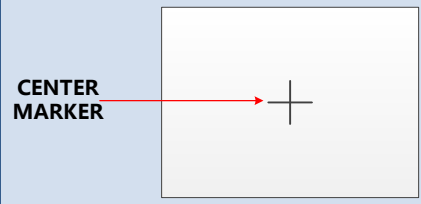
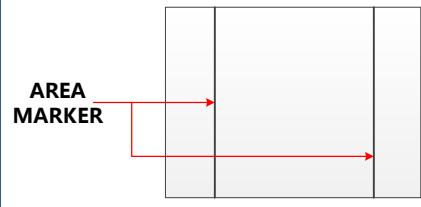
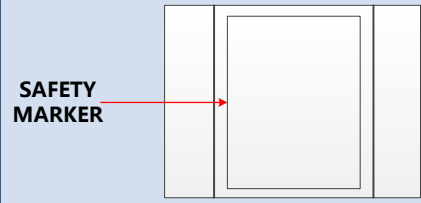
Marker	Illustration	Description
CENTER MARKER		This marker enables easier checking the center portion's focus.
AREA MARKER		This marker displays two lines to identify an area with a specified aspect ratio.
SAFETY MARKER		This marker displays a rectangle to identify the safety area with a specified percentage in Area Marker.

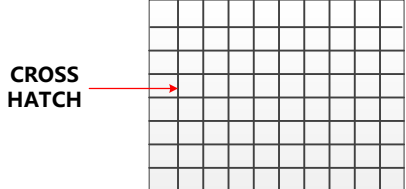
Marker	Illustration	Description
CROSS HATCH		This marker displays multiple vertical and horizontal lines to help when users check the composition of a picture.

MARKER MAT

The **Marker Mat** darkens the outside area of the marker setting display area. When Marker Mat is set as **OFF**, the outside area of marker is transparent. When Marker Mat is set as **HALF**, the outside area of marker is 50% blackness of the background. When Marker Mat is set as **BLACK**, the outside area of marker is totally in black. **For example**, set ASPECT as 16:9, AREA MARKER as 4:3, and SAFETY AREA as 95%, then, the comparison of these three MARKER MATs are as shown in Figure 4.1-10:



Figure 4.1-10 MARKER MAT

Tips

- All markers will be hidden in the following modes though the corresponding marker is enabled (the value is not OFF): NATIVE, PBP.
- The AREA MARKER, CENTER MARKER and SAFETY MARKER feature are available only when the MARKER item is set to ON, and the color of the marker lines are white.
- The safety marker area will change with the area marker.
- The cross hatch lines will display only in the single image or in PIP mode when **CROSS HATCH** is **ON**.

4.1.4 AUDIO Menu

The AUDIO menu items are used to set your audio source, audio level meter display preferences, the menu items are as shown in Figure 4.1-11:

MAIN		AUDIO	
STATUS	▶	AUDIO SOURCE	EBD
INPUT SELECT	▶	SPEAK OUT L	EBD CH1
MARKER	▶	SPEAK OUT R	EBD CH1
AUDIO	▶	AUDIO METER	OFF
DISPLAY	▶	METER SELECT	CH1-2
CLOSED CAPTION	▶	METER DIRECTION	HORIZONTAL
CONFIG	▶	METER POSITION	TOP
LOOK PROFILE	▶	METER DIS MODE	MODE1
FUNCTION KEY	▶	REF LEVEL	-20dB
KEY INHIBIT	▶	OVER LEVEL	-10dB

Figure 4.1-11 AUDIO Menu

The relationship of Items, Default Value, Domain Range and Description of the sub-item is as shown in Table 4.1-4:

Table 4.1-4 The Description of AUDIO Menu Items

Items	Default Value	Domain Range	Description
AUDIO SOURCE	EBD	<ul style="list-style-type: none"> EBD: output an audio signal embedded in SDI or HDMI signal. AUDIO1: output an audio signal that comes from the AUDIO IN1 interface. AUDIO2: output an audio signal that comes from the AUDIO IN2 interface UNDEF: no sound 	Select an audio format to output from speaker, headphone jack or AUDIO OUTPUT interface.
SPEAK OUT L	EBD CH1	When the audio source is set as EBD, the range of this item is EBD CH1~EBD CH16.	Set the embedded audio channel for the left speaker when SDI signal is input.
SPEAK OUT R	EBD CH2	When the audio source is set as EBD, the range of	Set the embedded audio channel for the right

Items	Default Value	Domain Range	Description
		this item is EBD CH1~EBD CH16.	speaker when SDI signal is input.
AUDIO METER	OFF	OFF/ON	Set whether to display the audio level meter.
METER SELECT	CH1-2	<ul style="list-style-type: none"> • CH1-2 • G1 • G2 • G3 • G4 • G1+G2 • G1+G3 • G1+G4 • G2+G3 • G2+G4 • G3+G4 • G1-4 	Used to select the audio channels that will be shown in the audio meter display. Each G* represents four channels, and each CH* represents a channel with specified number.
METER DIRECTION	HORIZONTAL	<ul style="list-style-type: none"> • VERTICAL • HORIZONTAL 	Used to set the displayed direction of audio meter.
METER POSITION	BOT LEFT/ BOTTOM	<p>When METER DIRECTION is set as VERTICAL, choose one of the followings:</p> <ul style="list-style-type: none"> • BOT LEFT: bottom left • BOT RIGHT: bottom right • TOP RIGHT: top right • TOP LEFT: top left <p>When METER DIRECTION is set as HORIZONTAL, choose one of the followings:</p> <ul style="list-style-type: none"> • BOTTOM • TOP 	Used to set the displayed position of audio meter.
METER DIS MODE	MODE1	<ul style="list-style-type: none"> • MODE1: simple audio meter • MODE2: audio meter with channel number • MODE3: audio meter with channel number and dB value 	Used to set the displayed mode for audio meter.
REF LEVEL	-20dB	-20dB/-18dB	Set the reference level
OVER LEVEL	-10dB	<ul style="list-style-type: none"> • -10dB • -8dB 	Set the overload level

Items	Default Value	Domain Range	Description
		<ul style="list-style-type: none"> -6dB -4dB -2dB 	

AUDIO LEVEL METER

The appearance of Audio Level Meter is as shown in Figure 4.1-12:

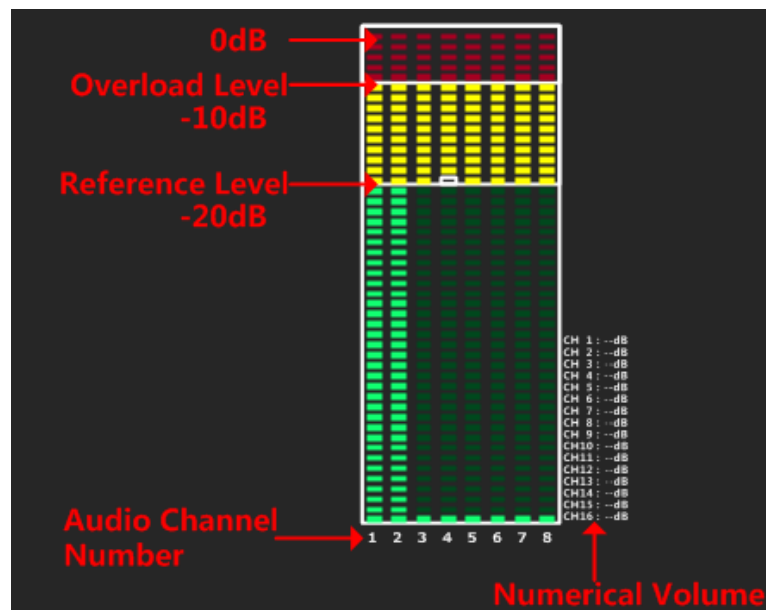

Figure 4.1-12 Audio Level Meter

METER SELECT item and **METER DIS MODE** item control the operational characteristics of Audio Metering, the former controls the amount of channels displayed in a meter.

For example: As shown in Figure 4.1-13, the meter displays at the left of the screen vertically, the **METER SELECT** is **G1+G2**, and the **METER DIS MODE** is **MODE3**, you can see the meter displays audio channel numbers and audio values beside the meter.

There are two white horizontal level lines in the white rectangle frame of audio meter, the upper is the **OVER LEVEL** line, and the lower is the **REFERENCE LEVEL** line. If the audio value is higher than the reference level, the audio bar over the reference level line will display in yellow, and if the audio value is higher than the over level, the audio bar over the **OVER LEVEL** line will display in red, thus you could observe the exceeded part intuitively.



Figure 4.1-13 The Position of the Audio Meter On Screen

AUDIO LEVEL METER POSITION

The position of AUDIO LEVEL Meter is controlled by METER DIRECTION and METER POSITION, the position of the audio meter on the screen could be as follows: **TOP LEFT VERTICAL, TOP RIGHT VERTICAL, BOT LEFT VERTICAL, BOT RIGHT VERTICAL, BOTTOM HORIZONTAL** and **TOP HORIZONTAL**. The illustrations of these positions are as shown in Figure 4.1-14:

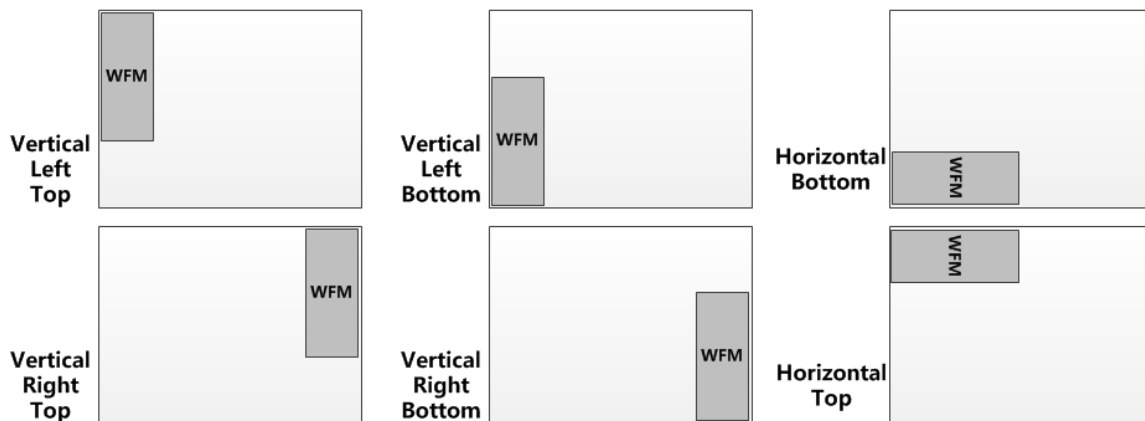

Figure 4.1-14 the Positions of Audio Meter

Particularly, if the **METER SELECT** item is set as **G1-4**, there will be 16 channels displayed in audio meter, and if the **METER DIRECTION** is **Horizontal**, the audio meter will display two meters separately on both sides of the screen. One displays 8 channels (1~8) on the bottom or top left of the screen, and the other displays 8 channels (9~10) on the bottom or top right of the screen, the bottom or top is decided by **METER POSITION**, as shown in Figure 4.1-15:

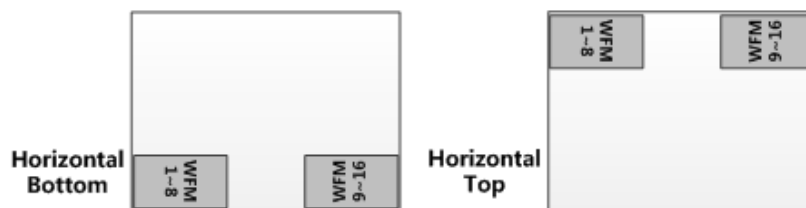

Figure 4.1-15 the Positions of the 16-channels Meter

Tips

- The prerequisite for the available settings of the display mode and the position of audio meter is that the **AUDIO METER** is **ON**.

4.1.5 DISPLAY Menu

The DISPLAY menu items are used to set your status information, wave form, vector, line wave, AFD and time code preference displayed on the screen, the menu items are as shown in Figure 4.1-16:

MAIN	DISPLAY
STATUS	STATUS DISPLAY AUTO
INPUT SELECT	AFD DISPLAY OFF
MARKER	WAVE FORM TYPE WAVE FORM
AUDIO	WAVE OVER LIMIT 50
DISPLAY	WAVE UNDER LIMIT 0
CLOSED CAPTION	WFM TRANS OPAQUE
CONFIG	WFM POSITION LEFT
LOOK PROFILE	TIME CODE OFF
FUNCTION KEY	
KEY INHIBIT	

Figure 4.1-16 DISPLAY SETUP Menu

The relationship of Items, Default Value, Domain Range and Description of the sub-item is as shown in Table 4.1-5:

Table 4.1-5 The Description of DISPLAY SETUP Menu Items

Items	Default Value	Domain Range	Description
STATUS DISPLAY	AUTO	OFF/ON/AUTO	Set whether to display Status information, including the resolution and frame rate of the source.
AFD DISPLAY	OFF	OFF/ON	Set whether to activate AFD information. ON is an effective value to AFD DISPLAY item only if the value of STATUS DISPLAY is AUTO or

Items	Default Value	Domain Range	Description
			ON.
WFM FORM TYPE	OFF	<ul style="list-style-type: none"> MODE1: WAVE FORM+ VECT75 MODE2: WAVE FORM+ VECT100 VECT100 VECT75 WAVE FORM OFF 	Switch the display mode among mode1, mode2, vector100, vector75 and wave form. When the wave form is selected, it will display the wave form, and when the vector* is selected, it will display the color component of the image signal.
WFM OVERLIMIT	100	50~100	Set the over limit of wave form.
WFM UNDERLIMIT	0	0~50	Set the under limit of wave form.
WFM TRANS	OPAQUE	<ul style="list-style-type: none"> OPAQUE TRANS1: the transparency is 25% TRANS2: the transparency is 50% TRANS3: the transparency is 75% 	Set the transparency of the wave form/vector
WFM POSITION	LEFT	<ul style="list-style-type: none"> LEFT: Left bottom RIGHT: Right bottom 	Set the displayed position for wave form/vector.
TIME CODE	OFF	<ul style="list-style-type: none"> OFF D-VITC LTC VITC 	Set whether to display time code, and set the time code display mode.

STATUS INFORMATION

Set **DISPLAY→STATUS DISPLAY** item to be ON or Auto, it will display the Status Information bar at the top left corner of the screen, and it displays the input channel and signal format.

The status information will be displayed only 15 seconds, then it will be closed automatically when STATUS INFORMATION item is set to be AUTO.

Source → SDI1
 Signal Format → 1080I59.94

The **Signal Format** usually displays as the following situations:

- **UNKNOWN**: appears if an unsupported signal is input.
- **NO SIGNAL**: appears if no signal is detected.

- Normal: the signal format is displayed as 1080i59.94, NTSC, or 1280X1024, etc. when the input is supported by the monitor.

Particularly, When the monitor is set in PIP or PBP mode by setting the **CONFIG→SUB IN TYPE** menu item, the **Status Information** for the main picture displays at the top left corner of the screen, and the **Status Information** for the slave picture displays at the top right corner of the screen.

Set **DISPLAY→STATUS DISPLAY** item to be OFF to completely turn the **Status Information** off, and it will effect on the AFD information display.

AFD (Active Format Description) INFORMATION

If activate the AFD information, the embedded aspect ratio signal and AFD code in the video signal will be extracted and displayed as an AFD marker at the top center of the screen.

Make sure you have set the **DISPLAY→STATUS DISPLAY** item to be ON or Auto, before you switch **DISPLAY→AFD DISPLAY** item to be ON.

Tips

- Please refer to the international standard SMPTE2016-1-2007 for the details about AFD display.

WAVE FORM & VECTOR

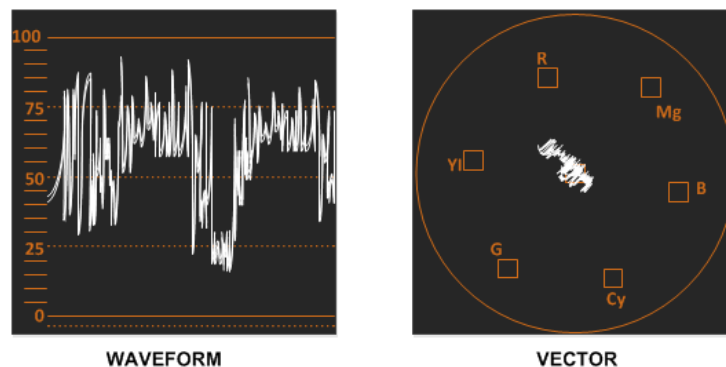

Figure 4.1-17 WAVEFORM and VECTOR

Set **DISPLAY→WFM FORM TYPE** item to be MODE1(WAVE FORM& VECT75), MODE2(WAVE FORM&VECT100), VECT100, VECT75, or WAVE FORM, the waveform window or the vector window will be displayed at the desired position on the image.

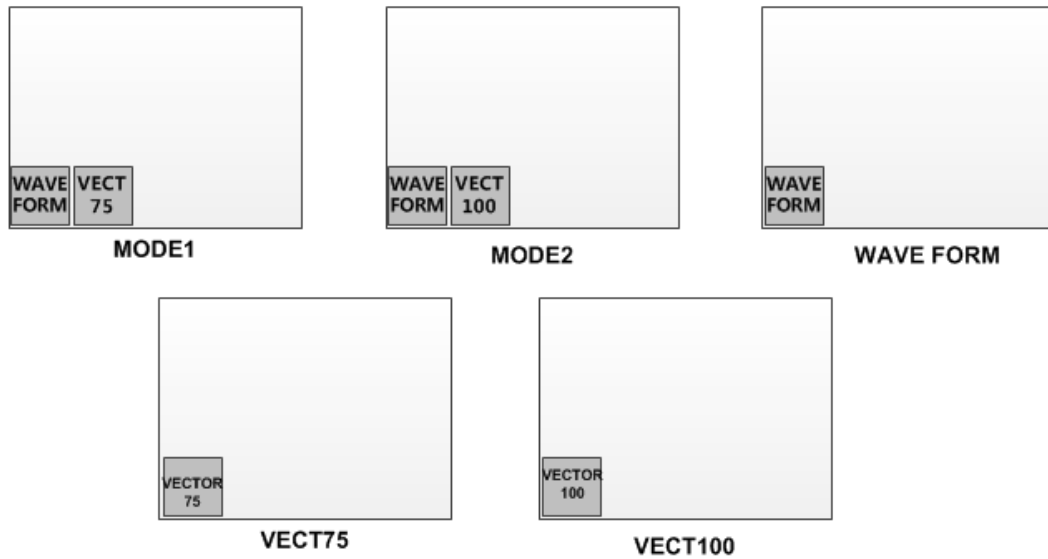

Figure 4.1-18 WAVE FORM TYPE

The **WFM POSITION** item is used to set the position of the wave form/vector display, and you can select from left bottom or right bottom.

The **WFM TRANS** item is used to set the transparent of the wave form window and the vector window.

Use the **WFM OVERLIMIT** item and the **WFM UNDERLIMIT** item to set the threshold for the wave form, and the waveform overstepping **WFM OVERLIMIT** or **WFM UNDERLIMIT** will be painted with distinctive color. The ordinary part is in white, and the higher part will be in red, and the lower part will be in blue.

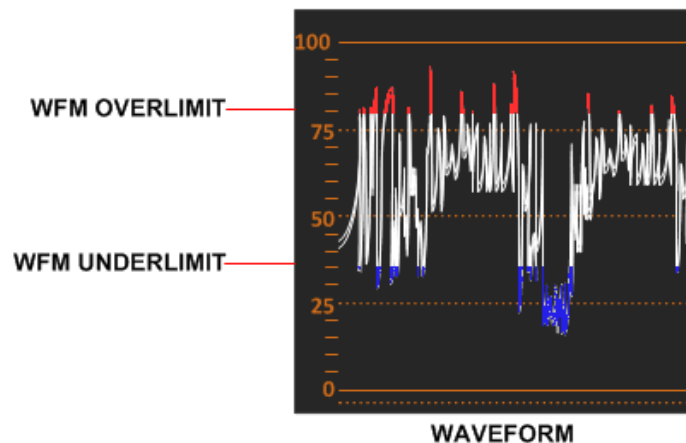

Figure 4.1-19 WAVEFORM WITH OVERLIMIT and WFM UNDERLIMIT

i Tips

- The waveform or vector is not available in PBP and NATIVE mode.

TIME CODE

The **DISPLAY→TIME CODE** setting is used to display a time code and set a desired format for time code, only available for SDI input.

The time code is displayed at the bottom center of the screen. The mode could be D-VITC, LTC or VITC, and the format is HH:MM:SS:FF. If there is no time code available, the monitor will display "--:--:--:--".



Figure 4.1-20 TIME CODE

4.1.6 CLOSED CAPTION Menu

The CLOSED CAPTION menu items are used to set whether to display the closed caption on screen, select the display mode and display standard, the menu items are as shown in Figure 4.1-21:

MAIN	CLOSE CAPTION	
STATUS ▶	SDI CC LOG	OFF
INPUT SELECT ▶	CLOSED CAPTION	OFF
MARKER ▶	SDI CC TYPE	AUTO1
AUDIO ▶	608 CHANNEL SEL	CC1
DISPLAY ▶		
CLOSED CAPTION ▶		
CONFIG ▶		
LOOK PROFILE ▶		
FUNCTION KEY ▶		
KEY INHIBIT ▶		

Figure 4.1-21 CLOSED CAPTION Menu

The relationship of Items, Default Value, Domain Range and Description of the sub-item is as shown in Table 4.1-6:

Table 4.1-6 The Description of CLOSED CAPTION Menu Items

Items	Default Value	Domain Range	Description
SDI CC LOG	OFF	OFF/ON	Set whether to display the SDI CC logo when detecting closed caption in SDI input signal.
CLOSED CAPTION	OFF	OFF/ON	Set whether to display the closed caption information. Only available when the SUB IN TYPE item is set to be OFF.
SDI CC TYPE	AUTO1	<ul style="list-style-type: none"> AUTO1: set to 608(VBI) for SD-SDI input and set to 608(708) for HD-SDI input. AUTO2: set to 608(ANC) for SD-SDI input and set to 608(708) for HD-SDI input. 608(708): display the 608 closed caption signal transmitted by EIA/CEA-708 standards. 608(ANC): display the ANC closed caption signal transmitted by EIA/CEA-608 or EIA/CEA-708 standards. 608(VBI): display the closed caption signal of the EIA/CEA-608 standards in Line 21. 	Set the closed caption type, and select 608(VBI) item when the input is CVBS.
608 CHANNEL SEL	CC1	<ul style="list-style-type: none"> CC1 CC2 CC3 CC4 TEXT1 TEXT2 TEXT3 TEXT4 	Select closed caption transmission channel.

CLOSED CAPTION

There will be a SDI CC logo displayed at the top center of the screen, which indicates available CLOSED CAPTION (CC for short) information in the current SDI signal source. Set **CLOSED CAPTION**→**SDI CC LOG** to be **ON** to enable this detection.

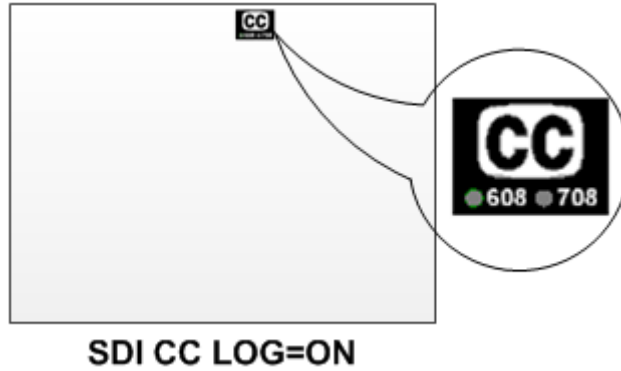

Figure 4.1-22 SDI CC LOGO

Set **CLOSED CAPTION** → **CLOSED CAPTION** to be **ON** to display the closed caption transmitted in the signal source, then, select a transmission standard accordant with the signal input among AUTO1(608(VBI)& 608(708)), AUTO2(608(ANC)& 608(708)), 608(708), 608(ANC), 608(VBI).

i Tips

- You should set **CONFIG** → **SUB IN TYPE** to be **OFF** to close the multiple images display mode, thus to display the closed caption in single image display mode.

4.1.7 CONFIG Menu

The CONFIG menu items are used to set Fast mode, multiple images display mode and settings, backlight, auto standby mode, aperture, language mode, horizontal flip, and uniformity, the menu items are as shown in Figure 4.1-23:

MAIN	CONFIG
STATUS	▶ FAST MODE OFF
INPUT SELECT	▶ FILM MODE DETECT OFF
MARKER	▶ SUB IN TYPE PBP
AUDIO	▶ SUB IN SELECT SDI1
DISPLAY	▶ PIP SIZE LARGE
CLOSED CAPTION	▶ PIP POSITION HORIZONTAL
CONFIG	▶ BACKLIGHT 15
LOOK PROFILE	▶ AUTO STANDBY OFF
FUNCTION KEY	▶ APERTURE 0
KEY INHIBIT	▶ LANGUAGE ENGLISH
	H FLIP OFF
	UNIFORMITY OFF
	FAN CONTROL OFF

Figure 4.1-23 CONFIG Menu

The relationship of Items, Default Value, Domain Range and Description of the sub-item is as shown in Table 4.1-7:

Table 4.1-7 The Description of CONFIG Menu Items

Items	Default Value	Domain Range	Description
FAST MODE	OFF	OFF/ON	Enable/Disable the fast mode.
FILM MODE DETECT	OFF	OFF/ON	Set whether to detect 24PsF mode.
SUB IN TYPE	OFF	PBP/PIP/OFF	Set the display mode of screen picture.
SUB IN SELECT	SDI2	<ul style="list-style-type: none"> • SDI1 • SDI2 • LINE1(CVBS) • LINE2(CVBS) • LINE2(Y/C) • LINE2(YPBPR) • HDMI 	Set the signal input for the slave image, refer to Table 4.1-9 for the details.
PIP SIZE	SMALL	SMALL/LARGE	Set the size of the slave picture in PIP mode.
PIP POSITION	BOT RIGHT	<ul style="list-style-type: none"> • BOT LEFT: bottom left • BOT RIGHT: bottom right • TOP RIGHT • TOP LEFT 	Set the position of the slave image in PIP mode.
BACK LIGHT	30	0~30	Set the backlight level of the LCD panel.
AUTO STANDBY	OFF	OFF/ON	Enable/Disable standby mode.
APERTURE	0	0~24	Set the sharpness level of the image. The higher the value, the sharper the image.
LANGUAGE	ENGLISH	<ul style="list-style-type: none"> • ENGLISH • CHINESE 	Select a language mode
H FLIP	OFF	OFF/ON	Set whether to inverse the image horizontally displayed.
UNIFORMITY	OFF	OFF/ON	Enable/Disable the uniformity function.
FAN CONTROL	OFF	OFF/ON	Enable/Disable the fan control.

Warning

- Particularly for LCM215-E, only when **BACK LIGHT** is less than or equal to 15, **FAN CONTROL** is adjustable, otherwise, when it is greater than 15, the fan will run automatically, that is to say, **FAN CONTROL** is **ON** and not adjustable !

FAST MODE

When displaying interlaced input signal, FAST mode is used to reduce the 3D de-interlacing processing time delay, set **CONFIG→FAST MODE** to be **ON** to enable the FAST mode. The fast mode feature has the appearance progressive input signal. While FAST mode is set as **OFF**, the monitor will adopt a 3D de-interlacing processing which will deal a frame of interlaced signal to be 2 full fields (an odd field and an even field), this will improve the quality of video with fine details and reduce the signal dithering.

Tips

- The fast mode is only effective for interlaced signals.

PIP PBP(Display Multiple Images)

To display two input signals simultaneously on the monitor's screen, you could set the **CONFIG→SUB IN TYPE** item to be **PIP** or **PBP**.

This monitor provides two modes for picture & picture display: **PIP**, **PBP**, and the relevant relationship of the two pictures are as shown in Figure 4.1-24:



Figure 4.1-24 Multiple Inputs

PIP (Picture in Picture)

The two pictures generated by two input signals separately are displayed one in another. One is displayed on full screen, called as the main picture, and the other is displayed in an inset window, called as the slave picture. In PIP mode, the relevant

position relationship of the main picture and the slave picture is set by **CONFIG→PIP POSITION** item, as shown in Figure 4.1-25:

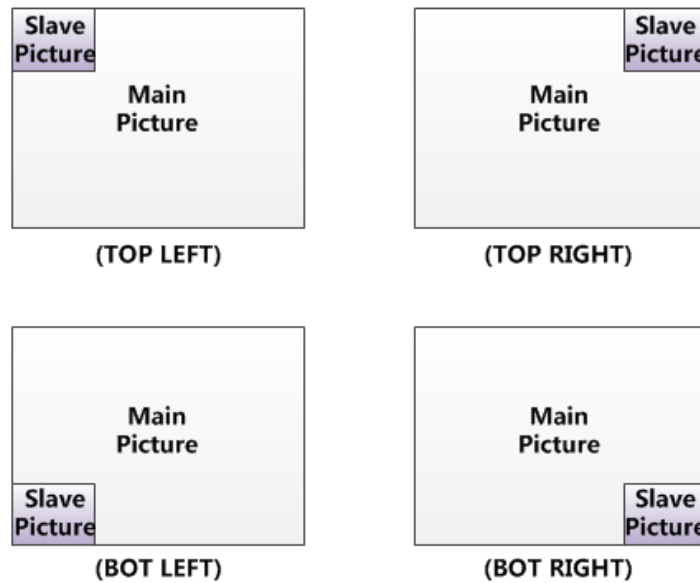

Figure 4.1-25 The Position Relationship in PIP Mode

Adjust the display size by **CONFIG→PIP SIZE** item, and there are two kinds of outlines for the slave picture, as shown in Figure 4.1-26:

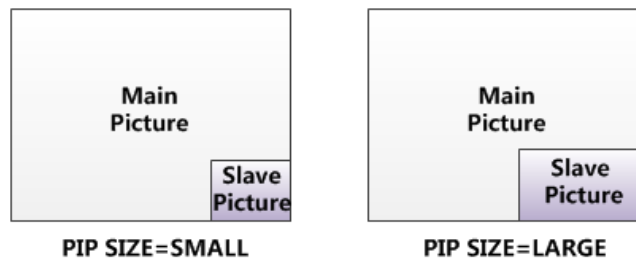

Figure 4.1-26 The Size for the Slave Picture

In **PIP** mode, it displays the waveform/vector or Audio Meter only for the signal source of the main picture. If the waveform/vector window is displayed, the Audio Meter will be display only at the top position (Top left or Top right) at the screen.

For example, the WFM displays at the bottom left, and the Audio Meter could be only displayed at the top position in case of collision, as shown in Figure 4.1-27:

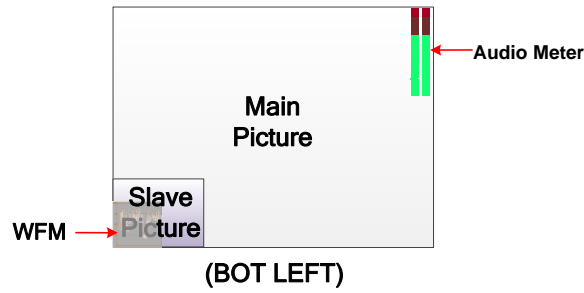

Figure 4.1-27 The Illustrate for WFM and Audio Meter Display

PBP(Picture by Picture)

The two pictures generated by two input signals separately are displayed side by side, and this function helps with white balance adjustment, and determining shooting angles between two cameras etc.

In **PBP** mode, the size of the main picture is as large as the slave picture's. The picture displayed at the left side is called as Main picture, and the right is called as Slave picture, as shown Figure 4.1-28:

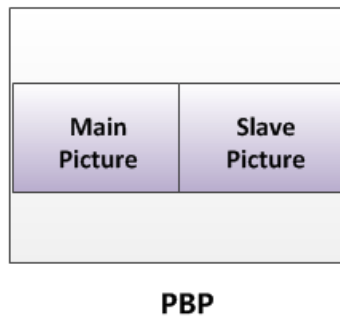

Figure 4.1-28 PBP Mode

In **PBP** mode, it displays the waveform/vector window for the whole screen, including the main signal and the slave signal, but for Audio Meter, it is only for the signal of the main picture, as shown in Figure 4.1-29.

In case of position collision, the waveform/vector window could only be displayed at the left bottom or right bottom of the screen, as shown in Figure 4.1-29, and meantime, the Audio Meter could be display only at the top position (Top left or Top right) at the screen in case of collision.

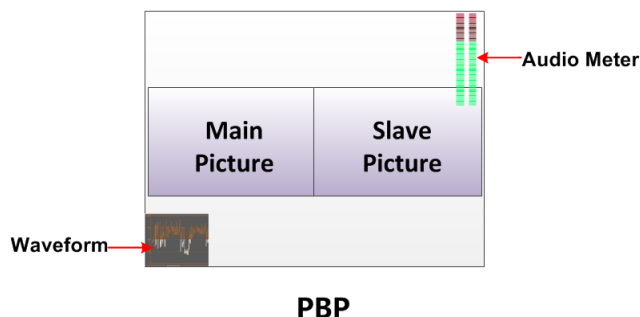

Figure 4.1-29 Position of WFM and Audio Meter in PBP Mode

Set Display Mode

The display mode on the screen could be single (SUB IN TYPE is OFF), PBP, PIP, set as instructed below:

OPERATION

Method 1: Set By menu item

Select the **Config** → **SUB IN TYPE** item, use **ENTER**, **UP** or **DOWN** key to select a display mode among **OFF**, **PBP** and **PIP**.

Method 2: Set By function key

Designate **PBP** function to a function key, then press this function key to switch its value among **OFF**, **PBP** and **PIP**.

For example, Select the **FUNCTION KEY** → **F1** item, and set its value as **PBP**, as shown in **Figure 4.1-30**, then, press F1 to switch the display mode.

FUNCTION		
F1	PBP	PBP
F2	NATIVE	OFF
F3	ANAMORPHIC	4:3
F4	FLASE COLOR	OFF
F5	FREEZE	OFF

Figure 4.1-30 Set the Function Key as PBP

■ **Scope for the signal source of the slave picture**

The selection scope of the signal source for the slave picture will be changing in accordance with the main picture's source, the available formats are as shown in Table 4.1-9:

Table 4.1-8 The Relationship of the Signal Source for Slave Picture and Main Picture

Signal Source for Main Picture \ Signal Source for Slave Picture	SDI1	SDI2	LINE1(CVBS)	LINE2(CVBS)	LINE2(Y/C)	LINE2(YSPR)	HDMI
SDI1	X	✓	✓	✓	✓	✓	✓
SDI2	✓	X	✓	✓	✓	✓	✓
LINE1(CVBS)	✓	✓	X	X	X	X	✓
LINE2(CVBS)	✓	✓	X	X	X	X	✓
LINE2(Y/C)	✓	✓	X	X	X	X	✓

Signal Source for Main Picture \ Signal Source for Slave Picture	SDI1	SDI2	LINE1(CVBS)	LINE2(CVBS)	LINE2(Y/C)	LINE2(YPSPR)	HDMI
LINE2(YPBPR)	✓	✓	✓	✓	×	×	✓
HDMI	✓	✓	✓	✓	✓	✓	×

- **Position for signal source menu:** The input signal information of the main picture displays at the top left corner of the screen, and the one of the slave picture displays at the top right corner of the screen.
- **Settings for signal source:** Press **INPUT** button to set the signal source for the main picture, and select **CONFIG→SUB IN TYPE** item to set the signal source for the slave picture.

H FLIP MODE

The input signal has been inverted horizontally by a mirror type in H FLIP Display mode.

Select the menu item **CONFIG →H FLIP** to be set to **ON**, or enable **H FLIP** in its coalesced Function Key in Function Key menu, thus to inverse the images horizontally.

The display result in the Horizontal **FLIP MODE** is as shown in Figure 4.1-31:



Figure 4.1-31 Horizontal Flip Mode

Tips

- **H FLIP** mode does not effect on Waveform/Vector, that is, the Wave Form of the input signal in **H FLIP** mode will not be inversed horizontally.

AUTO STANDBY

The Auto Standby mode is used to set the status of the monitor when the Power button is turned on or off.

- **ON:** set **AUTO STANDBY** item as **ON** to enable the auto standby mode. Thus,

when detecting no signal input or signal disappeared, the auto standby will be activated, and there will be a prompt during the process, as shown in **Figure 4.1-32**:



Figure 4.1-32 Entering the Auto Standby Mode

When detecting no signal input or signal disappeared, the power indicator will be lit in flash green for 10 seconds, and showing the standby prompt, after that, the monitor screen will be turned off, and it will be in auto standby mode, the POWER indicator is lit in red. Then, if the signal input is restored, the monitor screen will recover and lit up automatically.

- **OFF**: set **AUTO STANDBY** as **OFF** to disable the auto standby mode.

Press **POWER** button when the monitor is in operation mode, it will power off the monitor, otherwise, press **POWER** button when the monitor is off, thus it will power on the monitor, and the **POWER** indicator is lit in green.

4.1.8 LOOK PROFILE Menu

The LOOK PROFILE menu provides versatile color spaces, the items are used to switch to distinctive LOOK PROFILE feature and adjust color balance parameters, as shown in Figure 4.1-33:

MAIN	LOOK PROFILE
STATUS ▶	LOOK PROFILE D65 Rec709
INPUT SELECT ▶	RED GAIN 128
MARKER ▶	GREEN GAIN 128
AUDIO ▶	BLUE GAIN 128
DISPLAY ▶	RED BIAS 0
CLOSED CAPTION ▶	GREEN BIAS 0
CONFIG ▶	BLUE BIAS 0
LOOK PROFILE ▶	RESET
FUNCTION KEY ▶	USER LUT NAME XXXXXXXXXXXXX
KEY INHIBIT ▶	

Figure 4.1-33 LOOK PROFILE Menu

The relationship of Items, Default Value, Domain Range and Description of the sub-item is as shown in Table 4.1-9:

Table 4.1-9 The Description of LOOK PROFILE Menu Items

Items	Default Value	Domain Range	Description
LOOK PROFILE	D65	<ul style="list-style-type: none"> • D65 Rec709 • DCI P3 • Rec BT.2020 • ARRI_LOG_R709 • BMD_CC_FILM_V • BMD_PC_FILM_V2 • Canon_CinCL1_WDR • Canon_CinCL2_WDR • Pana_VLog_V709 • RED_RLF_RG3 • SONY_SL2_LC709A • SONY_SL3C_L709A • Panavision_R709 • USER1 • USER2 • USER3 • USER4 	Select a color look profile as your desired color space.
RED GAIN	128	0~128	Adjust the Red Gain
GREEN GAIN	128	0~128	Adjust the Green Gain
BLUE GAIN	128	0~128	Adjust the Blue Gain
RED BIAS	0	-127~127	Adjust the Red Offset
GREEN BIAS	0	-127~127	Adjust the Green Offset
BLUE BIAS	0	-127~127	Adjust the Blue Offset
RESET	--	--	Reset the Gain and Offset values to default values for the current profile set by LOOK PROFILE item.
USER LUT NAME	--	--	Display the user LUT name in this value area, it supports up to 16 characters.

LOOK PROFILE

The monitor is equipped with versatile color lookup profiles for several different color spaces. We provide 17 sheets of color profiles as follows:

- **Standard LUTs:** D65 Rec709, DCI P3, Rec BT.2020;
- **10 camera log to REC 709 LUT:** ARRI_LOG_R709, BMD_CC_FILM_V, BMD_PC_FILM_V2, Canon_CinCL1_WDR, Canon_CinCL2_WDR, Pana_VLog_V709, RED_RLF_RG3, SONY_SL2_LC709A, SONY_SL3C_L709A, Panavision_R709;

- 4 user LUTs: USER1, USER2, USER3, USER4.

Each profile has a group of RED/GREEN/BLUE GAIN and BIAS settings, and the value of RED/GREEN/BLUE GAIN and BIAS are all adjustable for your current LUT designated in **LOOK PROFILE** → **LOOK PROFILE** item.

User Luts

LCM156-E monitor is capable of loading customized calibration 3D LUTs to USER1, USER2, USER3 or USER4 in the LOOK PROFILE list. This advanced feature requires use of color management software (we support SpectralCal’s CalMAN currently), which could generate the customized calibration 3D LUTs, and OSEE Utility Tools (provided by OSEE) which could load the customized calibration 3D LUTs to specified monitor.

LOOK PROFILE Reset

Set **LOOK PROFILE** → **RESET** item, it will reset the Gain and Offset values to default values for the current profile selected in the **LOOK PROFILE** item.

4.1.9 FUNCTION KEY Menu

The FUNCTION KEY menu items are used to assign function to the function buttons (F1~F5) on the front panel, and turn the function on or off. The menu items of FUNCTION KEY are as shown in Figure 4.1-34:

MAIN	FUNCTION KEY
STATUS ▶	F1 FOCUS ASSIST
INPUT SELECT ▶	F2 NATIVE
MARKER ▶	F3 ANAMORPHIC
AUDIO ▶	F4 FALSE COLOR
DISPLAY ▶	F5 PBP
CLOSED CAPTION ▶	
CONFIG ▶	
LOOK PROFILE ▶	
FUNCTION KEY ▶	
KEY INHIBIT ▶	

Figure 4.1-34 FUNCTION KEY Menu

The relationship of Items, Default Value, Domain Range and Description of the sub-item is as shown in Table 4.1-10:

Table 4.1-10 The Description of FUNCTION KEY Menu Items

Items	Default Value	Domain Range	Description
F1	FOCUS ASSIST	NATIVE, ANAMORPHIC, BLUE ONLY, MONO, MARKER, AUDIO METER, FAST MODE, TC, MUTE, PBP, CC, FREEZE, FOCUS ASSIST, ZEBRA, H FLIP, FALSE COLOR, UNDEF	Set a function to F1 button
F2	NATIVE	the same as F1	Set a function to F2 button
F3	ANAMORPHIC	the same as F1	Set a function to F3 button
F4	FALSE COLOR	the same as F1	Set a function to F4 button
F5	PBP	the same as F1	Set a function to F5 button

Assign Function Key

To assign a desired function to a function button(F1~F5).

For example, set **FUNCTION KEY→F1** item to be **FALSE COLOR**, then press **F1** button on the front panel of the monitor, it will display the Function Menu at the left bottom of the screen, and F1 line is highlighted, press F1 button again to change the value for **FALSE COLOR** to be **ON** or **OFF**.

FUNCTION		
F1	FALSE COLOR	ON
F2	NATIVE	OFF
F3	MONO	OFF
F4	FREEZE	OFF
F5	PBP	OFF

NATIVE

Press the button to activate the native scan mode, which provides a 1:1 pixel to pixel mapped representation, thus to reproduce the images without changing the input signal's pixel count.



720P50
NATIVE=OFF



720P50
NATIVE=ON

INPUT SIGNAL	INPUT	OUTPUT
PAL	720X576	720X576
NTSC	720X483	720X483
720P24/23.98	1280X720	1280X720
720P25	1280X720	1280X720
720P30/29.97	1280X720	1280X720
720P50	1280X720	1280X720
720P60/59.94	1280X720	1280X720
1080SF24/23.98	1920X1080	1920X1080
1035I60/59.94	1920X1035	1920X1080
1080I50	1920X1080	1920X1080
1080I60/59.94	1920X1080	1920X1080
1080P24/23.98	1920X1080	1920X1080
1080P25	1920X1080	1920X1080
1080P30/29.97	1920X1080	1920X1080
1080P50	1920X1080	1920X1080
1080P60/59.94	1920X1080	1920X1080
2048X1080PSF24/23.98	2048X1080	2048X1080
2048X1080PSF25	2048X1080	2048X1080
2048X1080PSF30/29.97	2048X1080	2048X1080
2048X1080P24/23.98	2048X1080	2048X1080
2048X1080P25	2048X1080	2048X1080
2048X1080P30/29.97	2048X1080	2048X1080
2048X1080P48/47.94	2048X1080	2048X1080
2048X1080P50	2048X1080	2048X1080
2048X1080P60/59.94	2048X1080	2048X1080

ANAMORPHIC

Press the button to activate the anamorphic mode. For HD-SDI, 3G-SDI and 2K signals, you could set the de-squeeze modes to be **OFF(16:9)**, **X1.3**, **X2**, **X2 MAG**. For SD-SDI signals, set the aspect ratio to be **4:3** or **OFF(16:9)**.

This feature enables you to de-squeeze HD-SDI, 3G-SDI and 2K signals coming from camera utilizing anamorphic lenses that may not have a built-in de-squeeze feature of their own. This is quite useful in applications, such as outdoor post production, onset monitoring, real-time de-squeezing, etc.

The resolution of the input and output are as shown in Table 4.1-11:

Table 4.1-11 Resolution Relationship Between Input and Output

INPUT SIGNAL	ANAMORPHIC	INPUT	OUTPUT
PAL	4:3	720X576	1440X1080

INPUT SIGNAL	ANAMORPHIC	INPUT	OUTPUT
	16:9	720X576	1920X1080
NTSC	4:3	720X483	1440X1080
	16:9	720X483	1920X1080
720P24/23.98 720P25 720P30/29.97 720P50 720P60/59.94	OFF	1280X720	1920X1080
	X1.3	1280X720	1920x812
	X2	1280X720	1920x540
	X2 MAG	860X720	1920x804
1080SF24/23.98	OFF	1920X1080	1920X1080
	X1.3	1920X1080	1920X812
	X2	1920X1080	1920X540
	X2 MAG	1290X1080	1920X804
1035I60/59.94	OFF	1920X1035	1920X1080
	X1.3	1920X1035	1920X812
	X2	1920X1035	1920X540
	X2 MAG	1290X1035	1920X804
1080I50 1080I60/59.94 1080P24/23.98 1080P25 1080P30/29.97 1080P50 1080P60/59.94	OFF	1920X1080	1920X1080
	X1.3	1920X1080	1920X812
	X2	1920X1080	1920X540
	X2 MAG	1290X1080	1920X804
2048X1080PSF24/23.98 2048X1080PSF25 2048X1080PSF30/29.97 2048X1080P24/23.98 2048X1080P25 2048X1080P30/29.97 2048X1080P48/47.94 2048X1080P50 2048X1080P60/59.94	OFF	2048X1080	1920X1080
	X1.3	2048X1080	1920X762
	X2	2048X1080	1920X506
	X2 MAG	1290X1080	1920X804

BLUE ONLY

Press the button to activate BLUE ONLY mode that will remove red and green from the input signal, and only blue signal is displayed as a monochrome image on the screen.

MONO

Press the button to activate MONO mode that will display the image in monochrome presentation, inactivate this mode to display the screen in color mode.

MARKER

Press the button to activate the marker, including AREA MARKER, CENTER MARKER and SAFETY MARKER. Set the marker in MARKER menu, and refer to "4.1.3 MARKER Menu" for details.

AUDIO METER

Press the button to activate the audiometer. Set the audio meter in AUDIO menu, and refer to "4.1.4 AUDIO Menu" for details.

FAST MODE

Press the button to activate FAST mode which will reduce the 3D de-interlacing processing time delay.

TC

Press the button to toggle the TIME CODE value among **D-VITC**, **LTC**, **VITC** and **OFF**. The time code is displayed at the bottom center of the screen. Refer to "4.1.5 DISPLAY Menu" for details.

MUTE

Press the button to mute the sound, and there will be mute prompt  displayed at the bottom right position of the screen.

PBP

Press the button to toggle the display mode among PBP, PIP and OFF(single). In PBP mode or PIP mode, you can display two input signals simultaneously on the monitor's screen. You can specify the relative position of the two input pictures, and set the source for each picture, refer to "4.1.7 CONFIG Menu" for details.

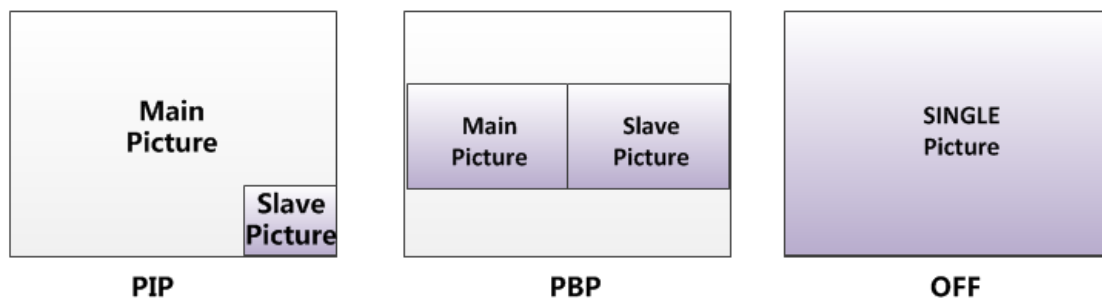

CC

Press the button to activate CC(closed caption) display. Refer to "4.1.6 CLOSED CAPTION Menu" for the details.

FREEZE

Activate this function to freeze the current frame displayed, press the function button again to release the freeze and continue to display.

FOCUS ASSIST

Press the button to toggle the FOCUS ASSIST display mode among COLOR, GRAY and OFF. The area whose current focus value is over the reference focus level will be

highlighted in a designated color set by **INPUT SELECT→FOCUS COLOR** item. Refer to “4.1.2 INPUT SELECT Menu” for the details.

ZEBRA

Press the button to activate the ZEBRA display. The image area whose luminance is higher than the reference **ZEBRA LEVEL** will be filled with a zebra pattern. Refer to “4.1.2 INPUT SELECT Menu” for the details.

H FLIP

Press the button to activate the horizontal flip display. The input signal will be inverted horizontally by a mirror type.

FALSE COLOR

Press the button to activate the FALSE COLOR display of luminance values. This function generates an artificial luminance map of the input source that can be useful to identify over exposed areas. The following illustration indicates what artificial color corresponds to what luminance level.

939~1023		Red
876~938		Orange
811~875		Light Orange
747~810		Yellow
582~746		Light Gray
418~581		Medium Gray
255~417		Dark Gray
190~254		Blue
126~189		Blue Purple
63~125		Light Purple
0~62		Purple



FALSE COLOR=OFF



FALSE COLOR=ON

4.1.10 KEY INHIBIT Menu

The KEY INHIBIT menu item is used to lock the setting so that they can't be changed

by an unauthorized user, and the menu item is as shown in Figure 4.1-35:

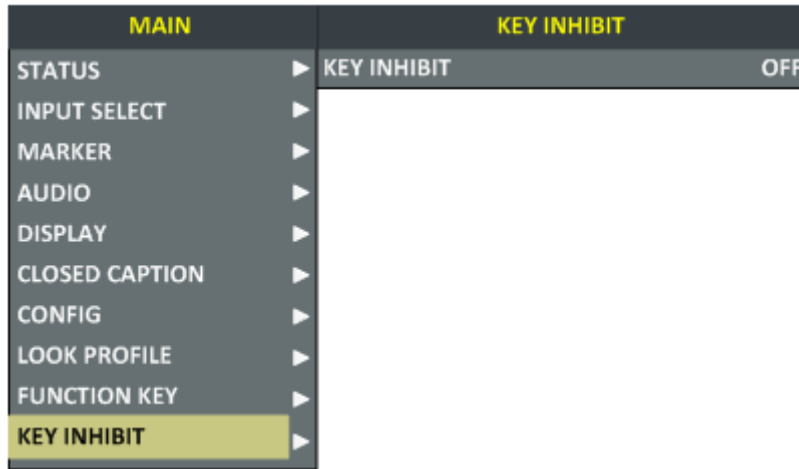

Figure 4.1-35 KEY INHIBIT Menu

The relationship of Items, Default Value, Domain Range and Description of the sub-item is as shown in Table 4.1-12:

Table 4.1-12 The Description of KEY INHIBIT Menu Items

Items	Default Value	Domain Range	Description
KEY INHIBIT	OFF	OFF/ON	Enable/Disable locking the setting values.

Security--KEY INHIBIT

Set **KEY INHIBIT**→**KEY INHIBIT** to be **ON** to enable the key inhibition, thus you can protect your setting values from being modified, and only **POWER**, **MENU**, **UP**, **DOWN**, **ENTER** buttons are available.

After enabling the key inhibition function, you can only see the **KEY INHIBIT** menu in On-screen menu. To disable the inhibition, use **MENU**, **UP**, **DOWN**, **ENTER** to release this inhibition.

Meanwhile, you could press the **POWER** key to turn on or off the device.

In inhibition status, press anyone of F1~F5 buttons, it will display a "KEY INHIBIT" prompt on right center of the screen, indicating the items are locked, as shown in Figure 4.1-36.



Figure 4.1-36 KEY INHIBIT Prompt

4.2 Menu Settings

When checking or modifying the value of the menu item, cooperating with the following buttons: **MENU**, **UP**, **DOWN**, **ENTER**. Take the following example to describe usage of these buttons.

Tips

- After you have loaded the Main Menu, it will be closed automatically if you do nothing operation with it in 60s.
-

Selecting the Menu Language

You can select one of languages (English or Chinese) for displaying the menu. The default language for the menu is ENGLISH. The following will teach you how to switch to Chinese.

Operation:

Step 1 Select CONFIG menu

Press **MENU** button to display the OSD menu, click **DOWN** button to select **CONFIG** menu.

Step 2 Select the value of the Language item

Press **ENTER** button to get into the **CONFIG** menu items, and click **DOWN** button to select the sub-item **LANGUAGE**, then, click **ENTER** button to get into the sub-value list, as shown in Figure 4.2-1, the current control icon is in **ENGLISH**.

MAIN		CONFIG	
STATUS	▶	FAST MODE	OFF
INPUT SELECT	▶	FILM MODE DETECT	OFF
MARKER	▶	SUB IN TYPE	PBP
AUDIO	▶	SUB IN SELECT	SDI1
DISPLAY	▶	PIP SIZE	LARGE
CLOSED CAPTION	▶	PIP POSITION	HORIZONTAL
CONFIG	▶	BACKLIGHT	15
LOOK PROFILE	▶	AUTO STANDBY	OFF
FUNCTION KEY	▶	APERTURE	0
KEY INHIBIT	▶	LANGUAGE	ENGLISH
		H FLIP	OFF
		UNIFORMITY	OFF
		FAN CONTROL	OFF

Figure 4.2-1 Select the Value of Language

Step 3 Confirm the modification of the value of sub-item

Click **DOWN** button to select the sub-item **LANGUAGE** to **Chinese**, as shown in Figure 4.2-2, press **ENTER** button to confirm the modification.

主菜单		系统配置	
状态显示	▶	快速模式	关闭
输入设置	▶	电影模式检测	关闭
标记设置	▶	子画面类型	PBP
音频设置	▶	子画面输入源	SDI1
显示设置	▶	PIP大小	小
隐藏字幕	▶	PIP位置	右下
系统配置	▶	背光	15
色彩风格	▶	自动关机	关闭
功能键设置	▶	清晰度	0
按键锁定	▶	语言	中文
		水平翻转	关闭
		均匀性	关闭
		风扇控制	关闭

Figure 4.2-2 Switching the Value of LANGUAGE

Step 4 Exit the Main Menu

Click **MENU** button to exit the Main Menu.

Chapter 5 Specifications

5.1 Product detailed information

Specification	Values				
Model	LCM156-E	LCM170-E	LCM215-E	LCM230-E	LCM240-E
Dimension	15.6"	17.3"	21.5"	23"	24"
Dimension (WxHxDmm)	380.7x240x70.5	421.8x264.3x73.5	520.0x322.0x78.0	556.5x340.5x75.5	569.9x380.7x90.5
Pixel Pitch (WxHmm)	0.179x0.179	0.199x0.199	0.24825x0.24825	0.2652x0.2652	0.270x0.270
Aspect Ratio	16:9	16:9	16:9	16:9	16:10
Display Area (WxHmm)	344.16x193.59	381.90x214.80	476.64x268.11	509.184x286.416	518.4x324.0
Viewing Angle (HxV)	178° x178°				
Color Depth	1.073G colors	1.073G colors	16.7M colors(6bit + Hi-FRC)	16.7M colors(6bit + A-FRC)	1.073G colors (RGB 10-bits)
Resolution	1920×1080	1920×1080	1920×1080	1920×1080	1920×1200
Contrast	700:1(Typ.)	600:1(Min)	1000:1(Typ.)	1000:1(Typ.)	1000:1(Typ.)
Luminance (cd/m ²)	300	300	1000	250	250
Response Time (ms)	15	35	14	14	12(Max.)
Backlight	RGB LED	White LED	White LED	White LED	RGB LED
Backlight Life(Hrs)	15000	15000	30000(Min)	30000(Min)	50000(Min)
Work Temperature	0° C~50° C				
Power Supply	5A12V DC	100~240V 50/60Hz AC			
Power Consumption	40W	30W	70W	32W	100W
Video Input Interface	CVBS(X2), S-Video, YPbPr, HDMI(DVI-D), 3G/HD-SDI(X2)	HDMI(DVI-D), 3G/HD-SDI(X2)			
Video Output Interface	CVBS(X2), S-Video, YPbPr, 3G/HD-SDI(X2)	3G/HD-SDI(X2)			
Audio Input Interface	2CH Analog Stereo, 5dBu, Impedance ≥ 47K, RCA(X4)	---			
Audio Output Interface	1CH Analog Stereo, 5dBu, Impedance ≤ 500Ω, RCA(X2)	---			

Specification	Values	
Control Interface	GPI(6GPI Input RJ45)X1	---
	RS485(cascade RJ45) X2	---
	Ethernet(10/100 M adaptive RJ45) X1	Ethernet(10/100M adaptive RJ45) X1
Signal Formats	CVBS: PAL, NTSC	---
	HD-SDI: 1080i50, 1080i 59.94, 1080i 60, 720p50, 720p 59.94, 720p 60, 1035i59.94, 1035i 60	HD-SDI: 1080i50, 1080i 59.94, 1080i 60, 720p50, 720p 59.94, 720p 60, 1035i59.94, 1035i 60
	3G-SDI: 1080p50, 1080p60	3G-SDI: 1080p50, 1080p60
CVBS Input/Output		
Signal Type	NTSC, PAL	---
Signal Amplitude	1Vp-p+/-3dB	---
Impedance	75Ω	---
Return Loss	>40 dB to 5 MHz	---
DC Offset	0V±0.05 V	---
Frequency Response	±0.2 dB to 5 MHz	---
Differential Gain	<1%	---
Differential Phase	<1.5°	---
3G-SDI /HD-SDI Input/Output		
Signal Type	SMPTE 424M, SMPTE 292M, SMPTE 297M	
Connector	BNC per IEC 169-8	
Impedance	75Ω	
Return Loss	>15 dB 270 MHz to 1.5 GHz >10 dB up to 3 GHz	
Maximum Signal Level	800 mV pk-pk 10%	
Signal Amplitude	800 mV pk-pk 10%	
DC Offset	0 V ±0.5 V	
Overshoot	<10%	
Jitter	<0.2 UI	
Rise/Fall Time	<270 ps for 1.5 Gb/s HD <135 ps for 3 Gb/s HD	

Specification	Values
Extinction Ratio	>8
Back Reflection	<-14 dB

*The unit about the appearance attributes in above table is mm.

5.2 Optional Accessories

You can select the following accessories for LCM-E series monitors optionally:

Type	Model	Description
Battery Plate	LCM-A-BM-V	V-mount battery plate
Battery Plate	LCM-A-BM-AB	AB-mount battery plate
Sunhood suit	LCM170-HOOD	Sunhood(LCM170-E)
Sunhood suit	LCM215-HOOD	Sunhood(LCM215-E)
Sunhood suit	LCM230-HOOD	Sunhood(LCM230-E)
Sunhood suit	LCM240-HOOD	Sunhood(LCM240-E)
Protective screen	LCM170-E-Cover	Protective screen (LCM170-E)
Protective screen	LCM215-E-Cover	Protective screen (LCM215-E)
Protective screen	LCM230-E-Cover	Protective screen (LCM230-E)
Protective screen	LCM240-E-Cover	Protective screen (LCM240-E)
Hanger	LCM-Hanger	LCM-E general hanger with inch thread
OSEE Monitor Adapter C-Stand	LCM-CA	OSEE Monitor Adapter C-stand

1. Battery Plate

If you want to use a battery as your backup power supply, you can choose the battery plate listed in the optional accessories table above, and you can select two types of battery plate according to your needs: V-mount battery plate or AB-mount battery plates, as shown in Figure 5.2-1:

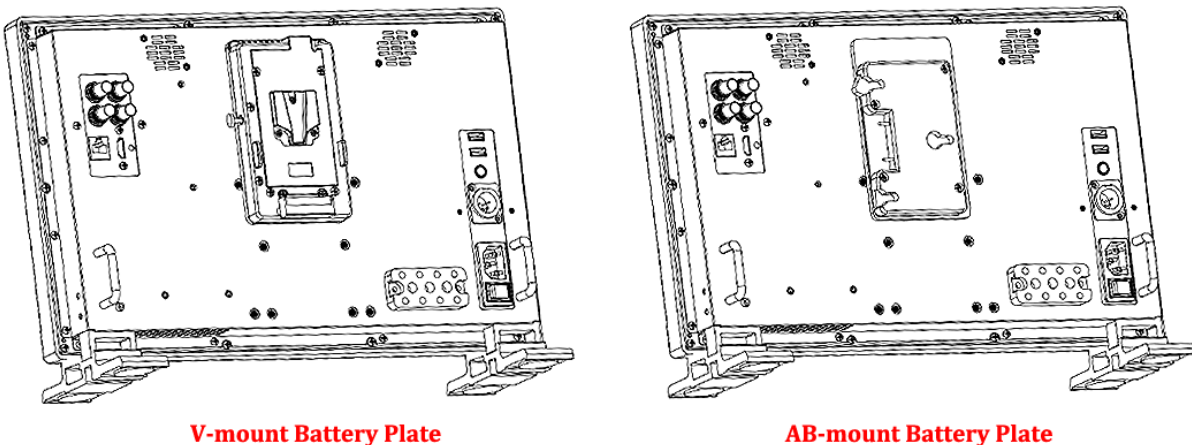

Figure 5.2-1 V-mount and AB-mount Battery Plate

There are two kinds of methods for mounting the battery plate: in portrait or in landscape. For V-mount battery plate, as shown in Figure 5.2-2 and Figure 5.2-3, and for AB-mount Battery Plate, as shown in Figure 5.2-4 and Figure 5.2-5:

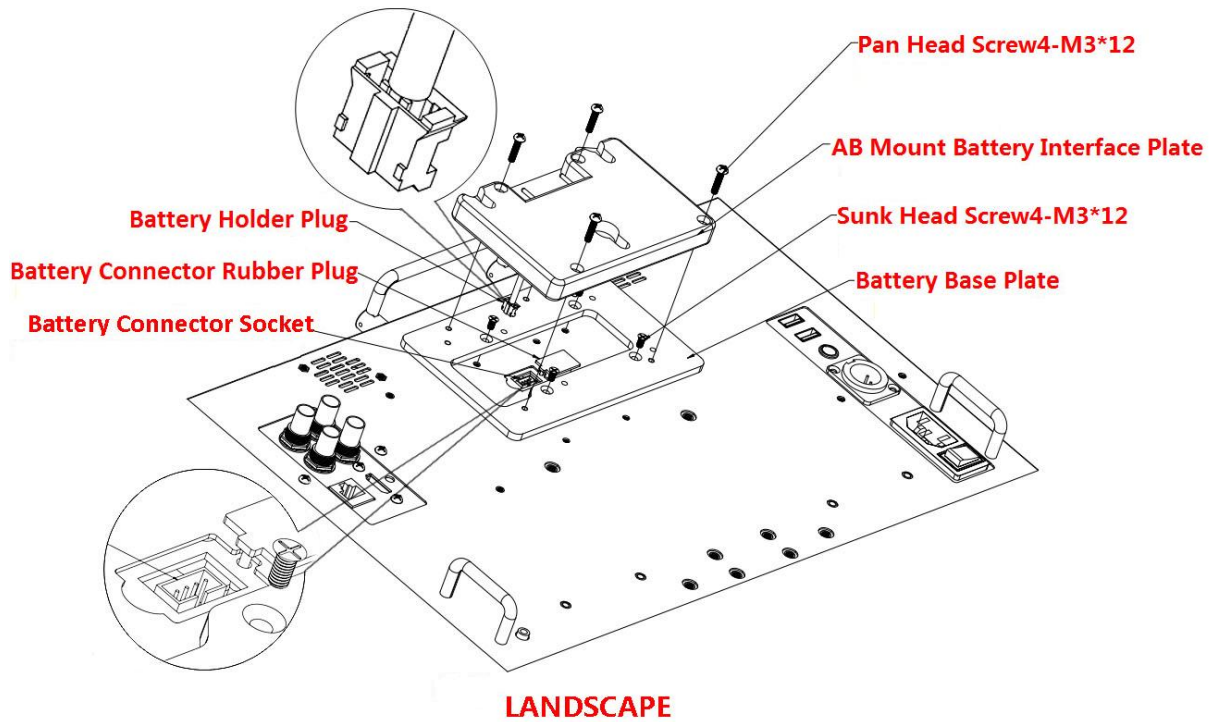

Figure 5.2-2 AB-mount Battery Plate in Landscape

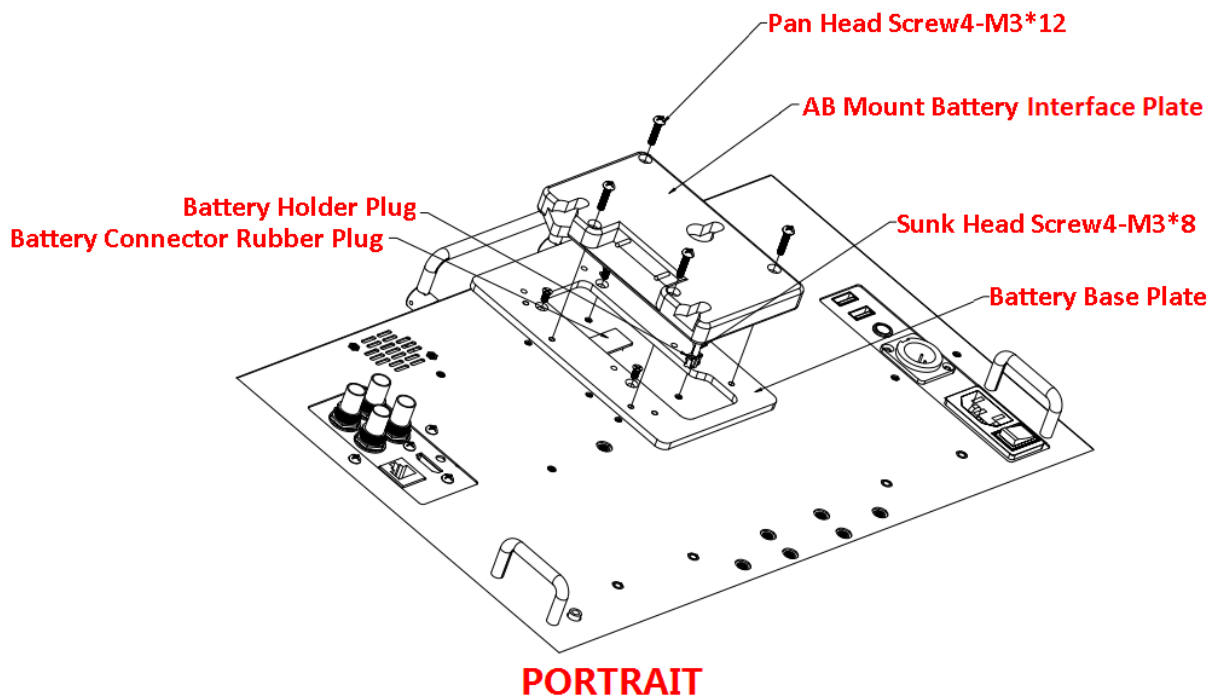

Figure 5.2-3 AB-mount Battery Plate in Portrait

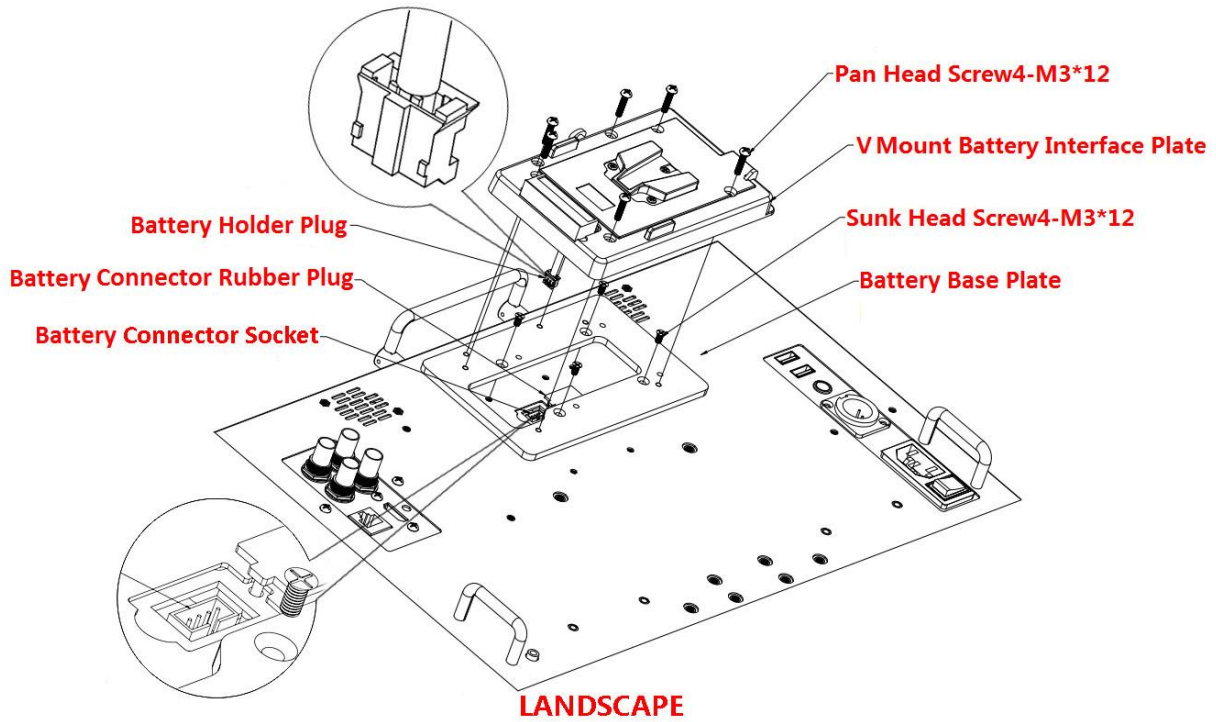

Figure 5.2-4 V-mount Battery Plate in Landscape

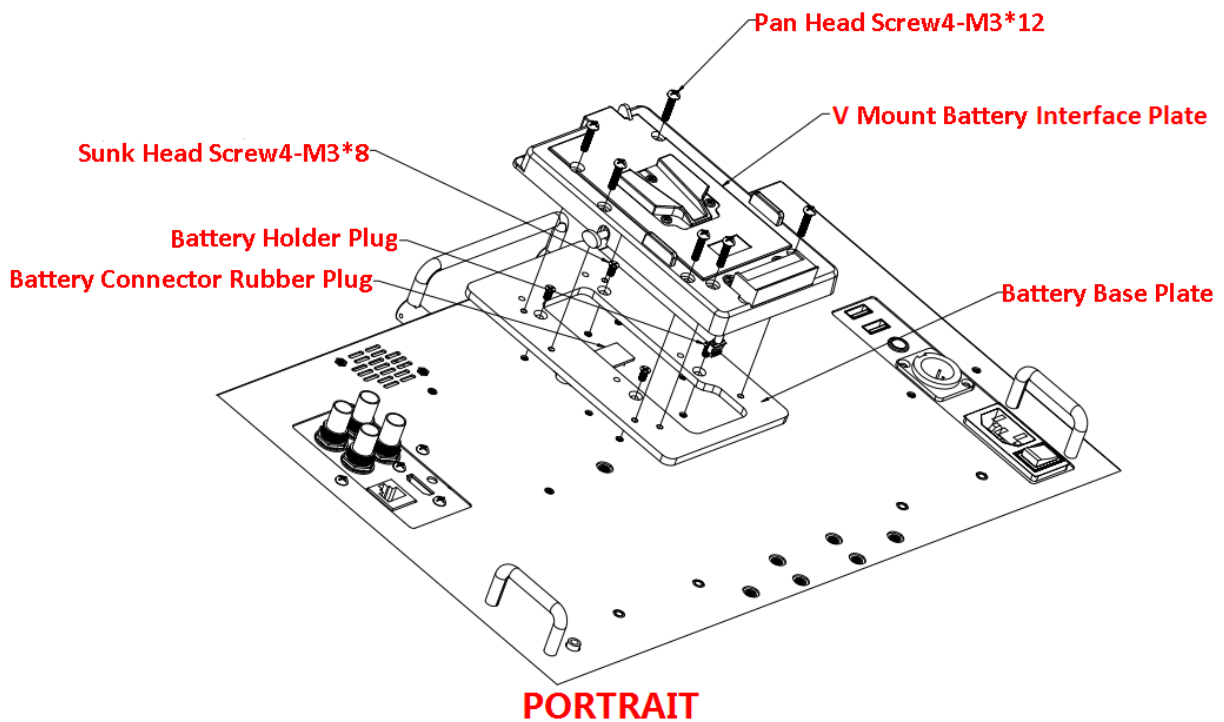

Figure 5.2-5 V-mount Battery Plate in Portrait

2. Sunhood

In case of diffusion light and direct illumination, we can use sunhood for the

LCM-E series monitors for images supervision. Mount the sunhood as shown in Figure 5.2-6, Figure 5.2-7, Figure 5.2-8 and Figure 5.2-9:

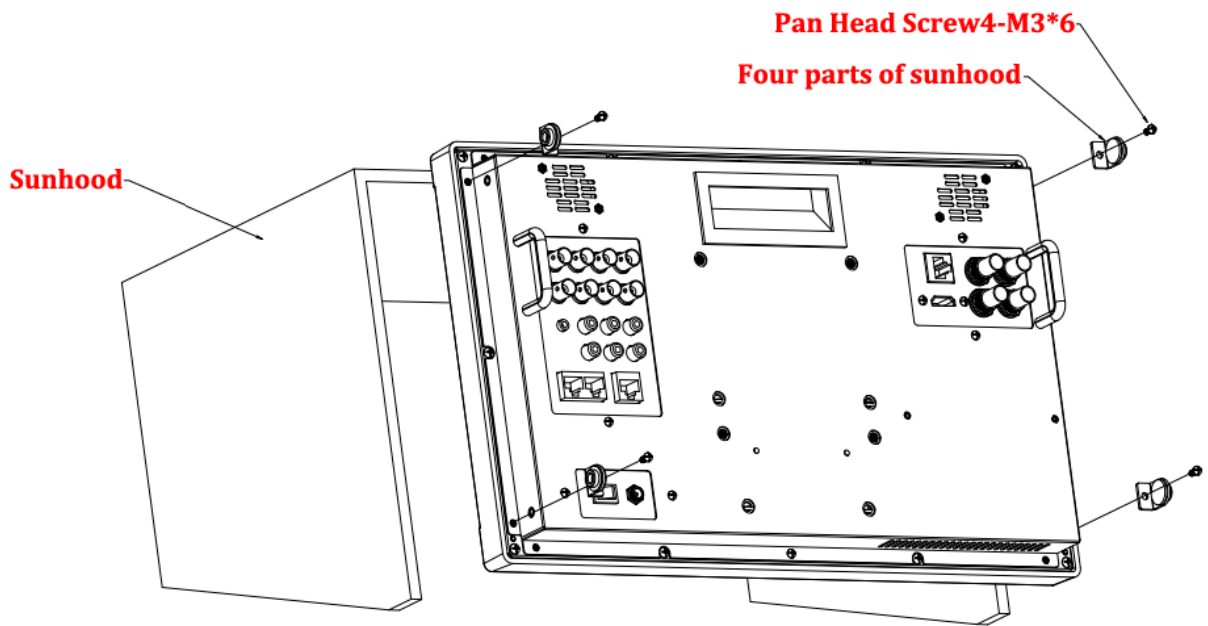

Figure 5.2-6 Mount a Sunhood for LCM156-E

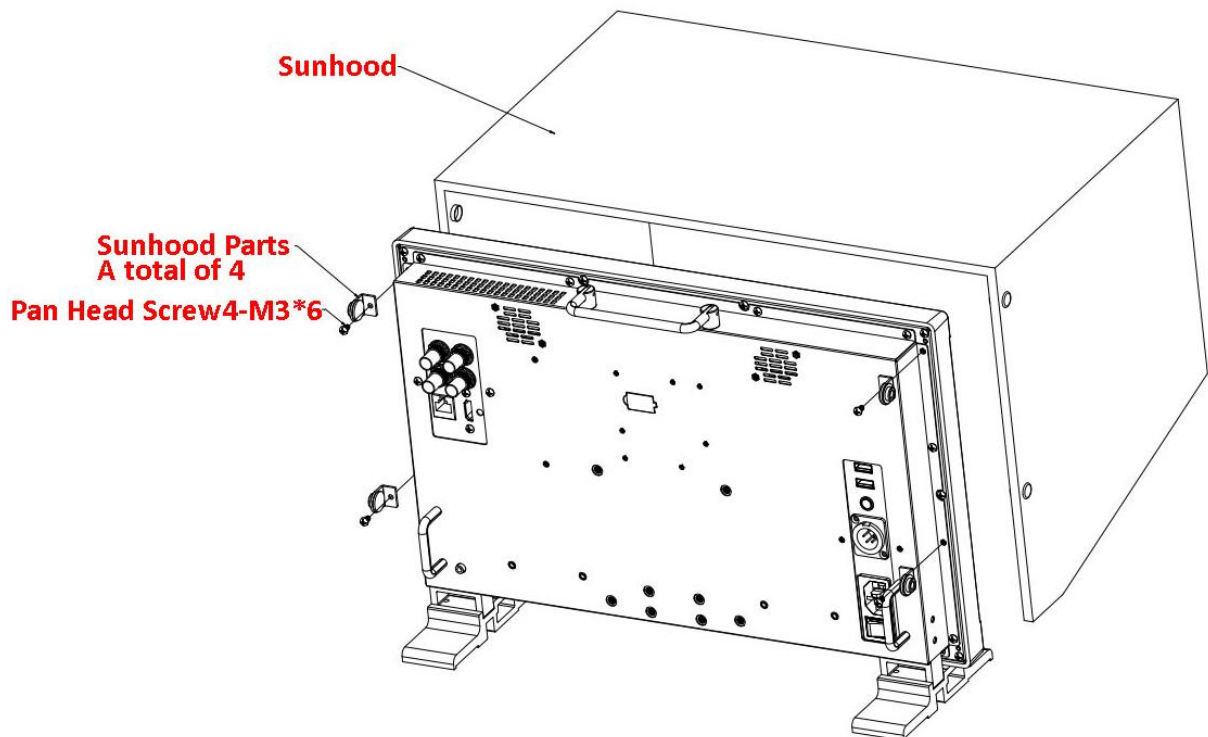

Figure 5.2-7 Mount a Sunhood for LCM170-E/LCM215-E

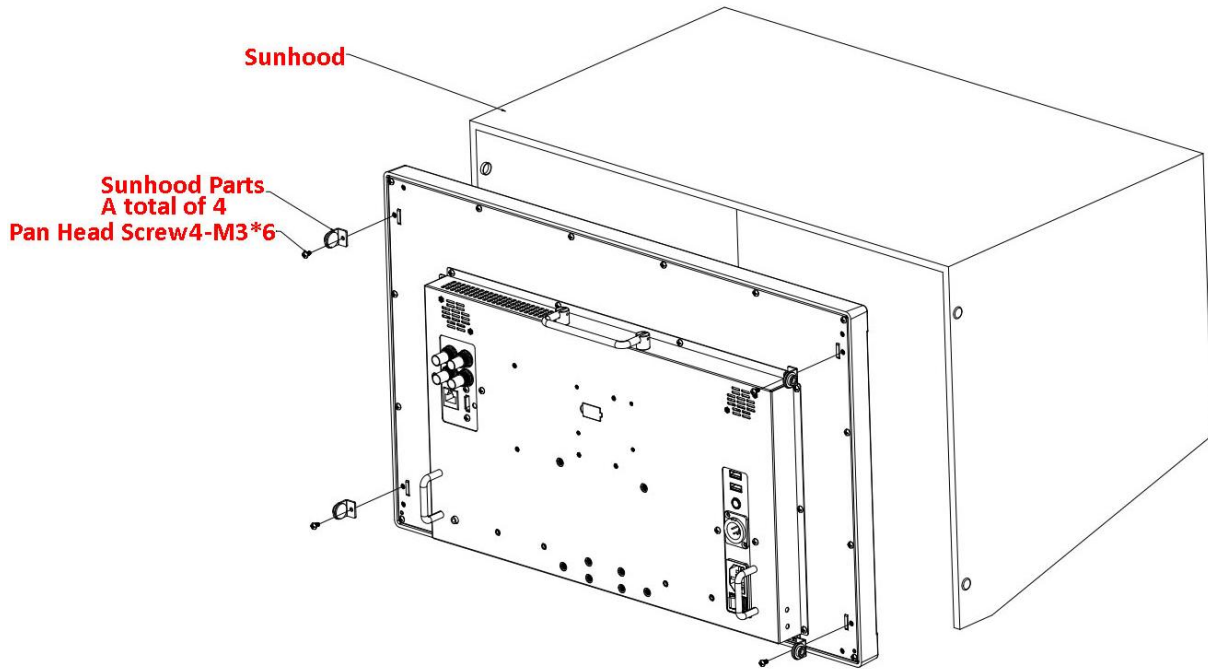

Figure 5.2-8 Mount a Sunhood for LCM230-E

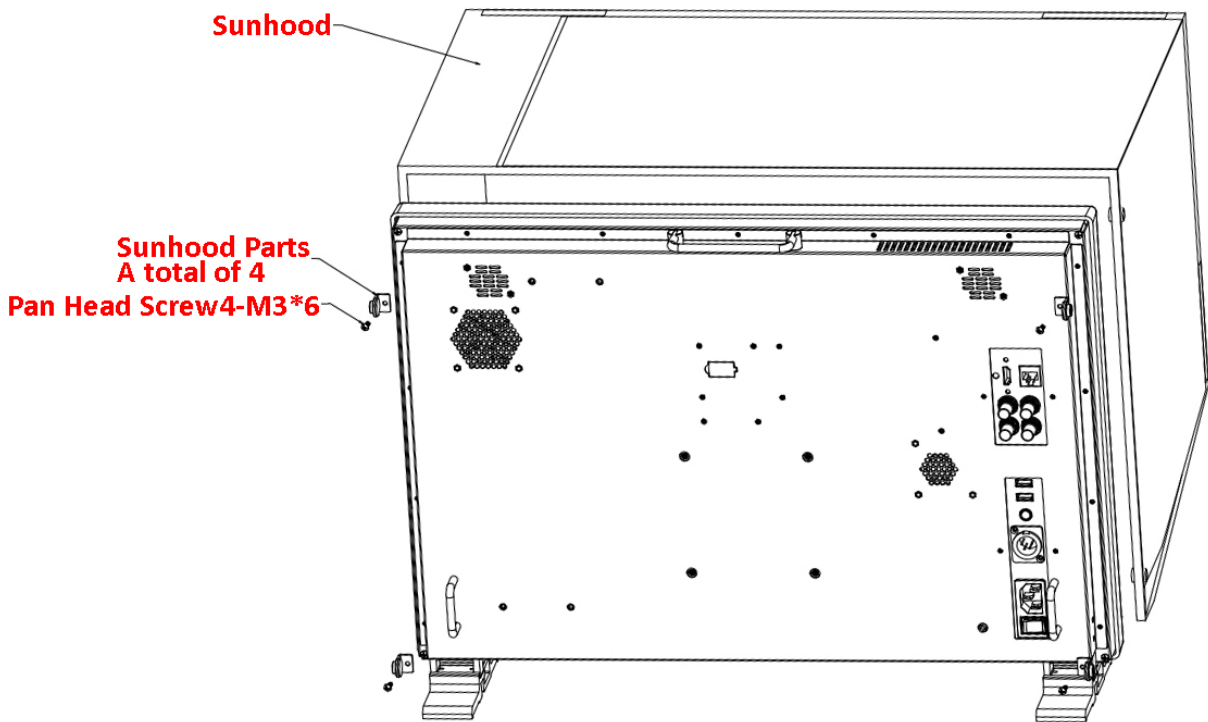

Figure 5.2-9 Mount a Sunhood for LCM240-E

3. Protective Screen

Choose the protective screen to protect your monitor screen. Mount the protective screen as shown in Figure 5.2-10, Figure 5.2-11, Figure 5.2-12 and

Figure 5.2-13:

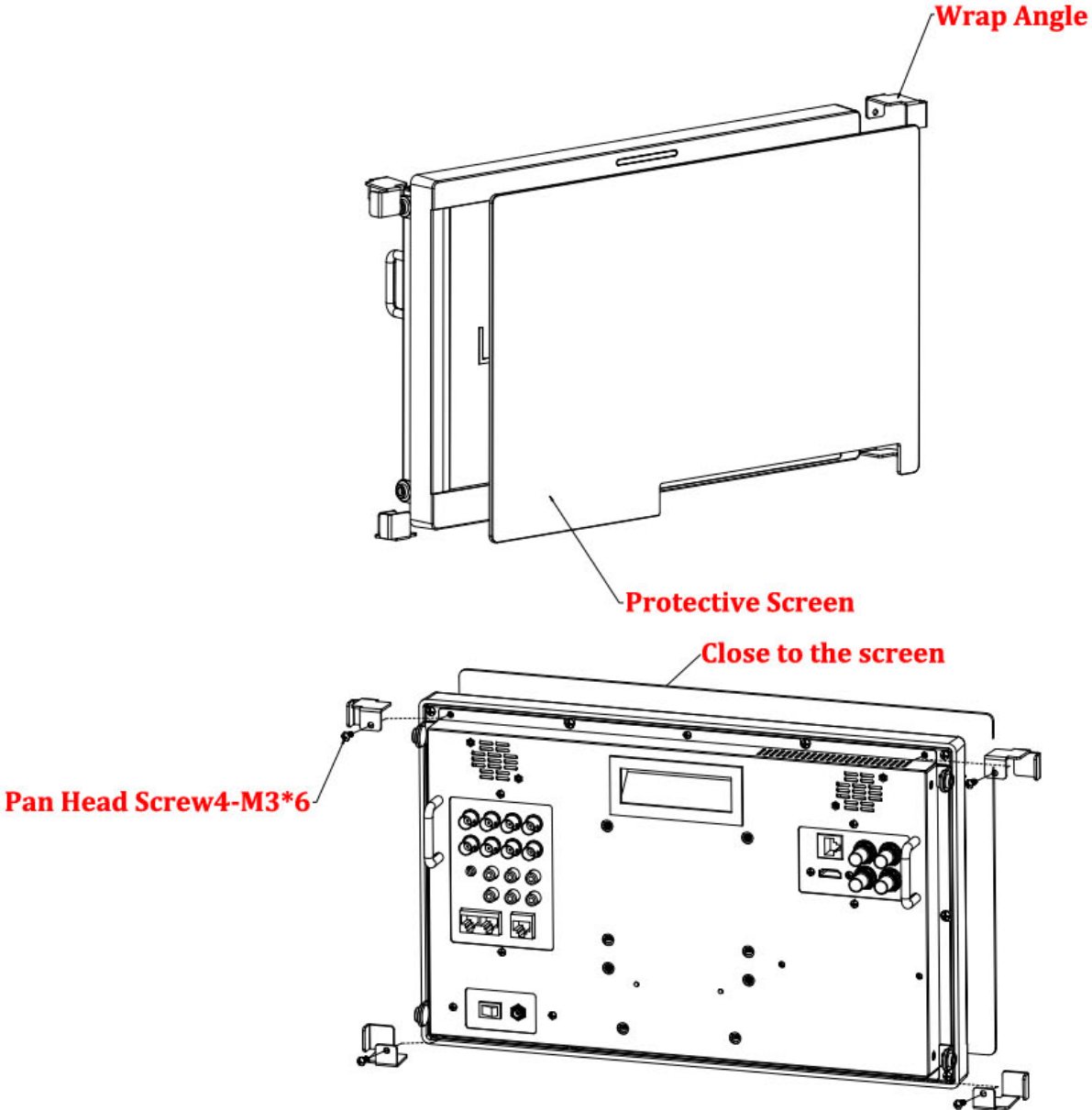

Figure 5.2-10 Mount a Protective Screen for LCM156-E

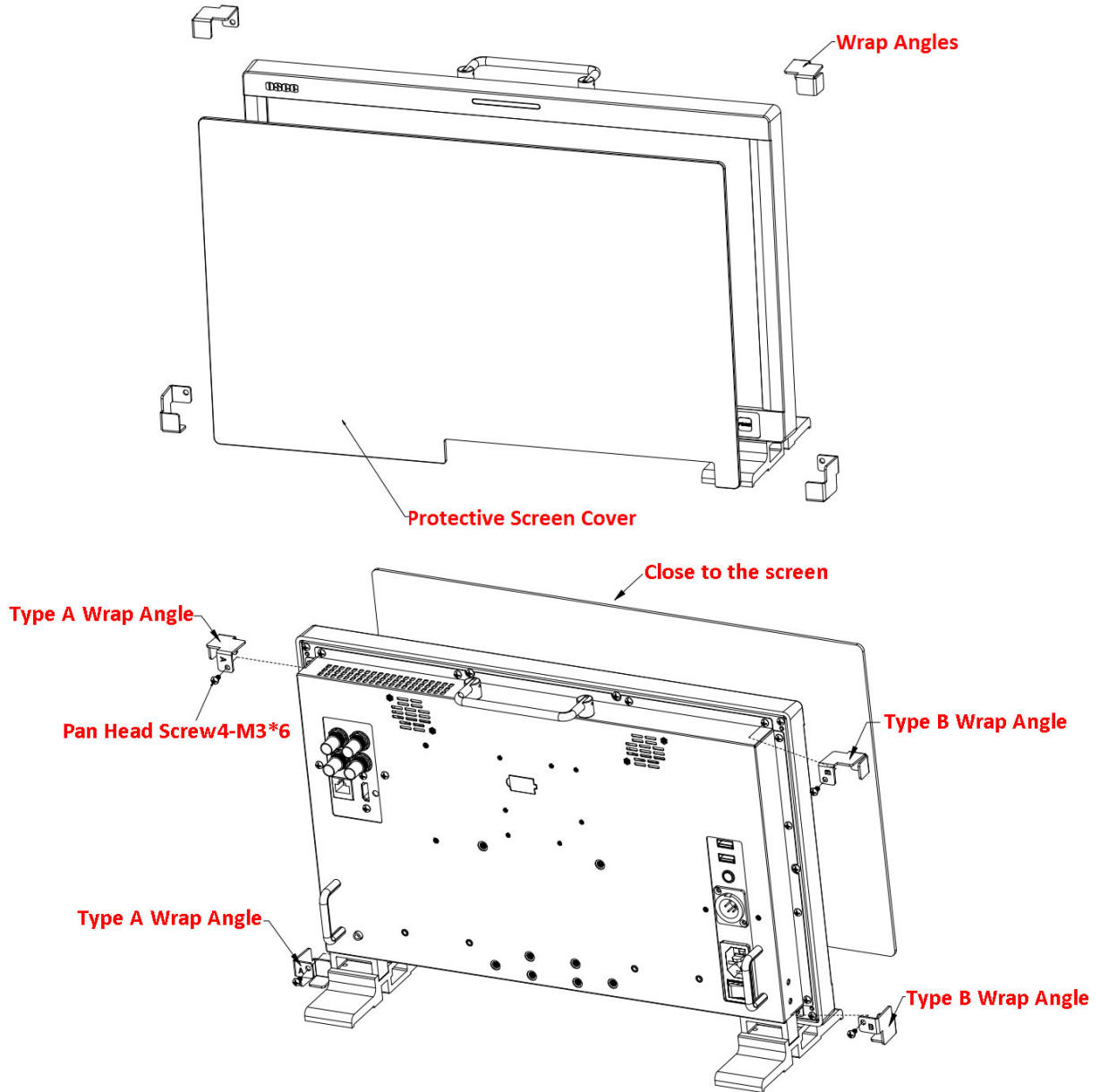

Figure 5.2-11 Mount a Protective Screen for LCM170-E/ LCM215-E

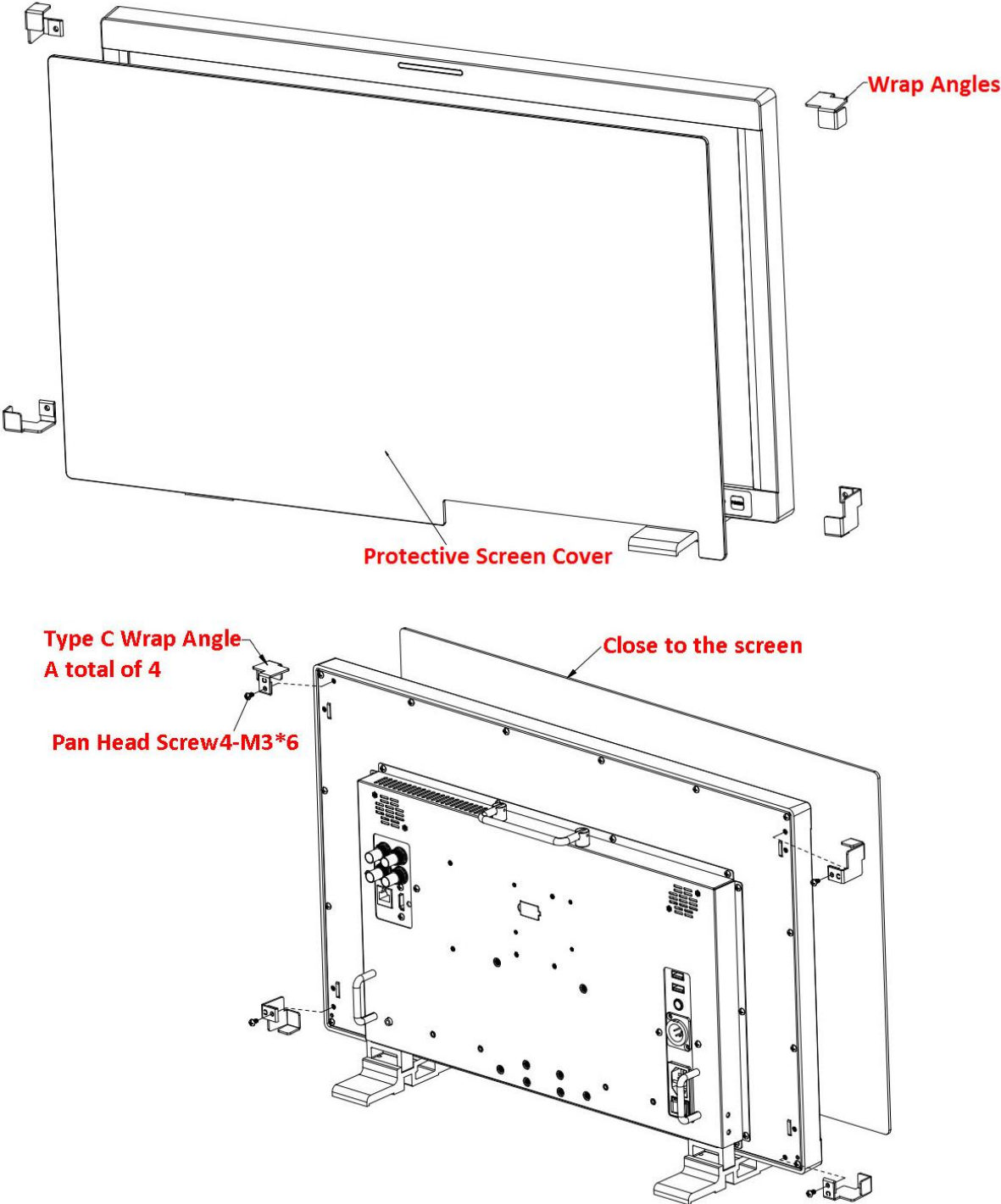

Figure 5.2-12 Mount a Protective Screen for LCM230-E

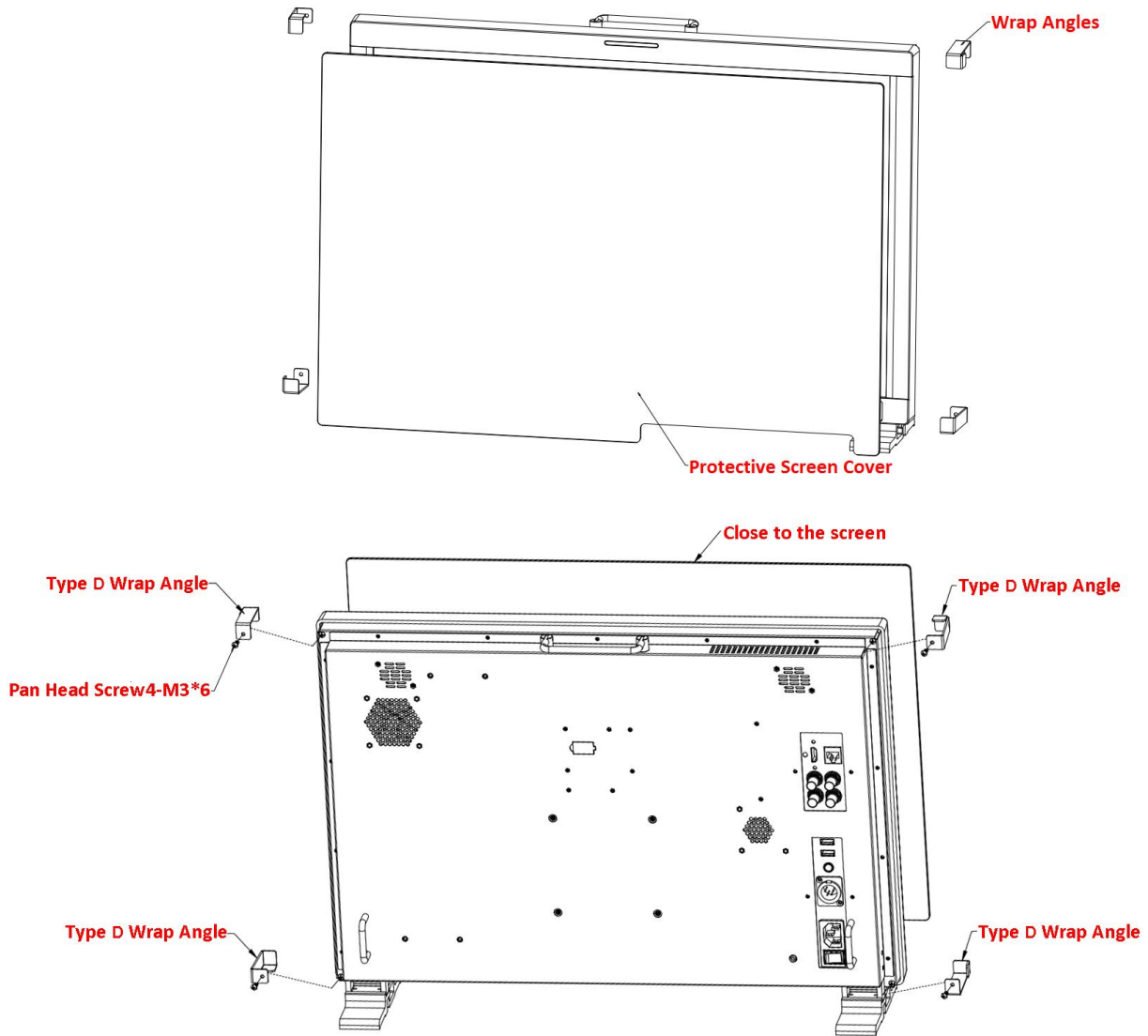

Figure 5.2-13 Mount a Protective Screen for LCM240-E

4. OSEE Monitor Adapter C-Stand

Each monitor can be mounted to any stand with an OSEE Monitor adapter C-Stand, the connection method is as shown in Figure 5.2-14, and the usage is as shown in Figure 5.2-15:

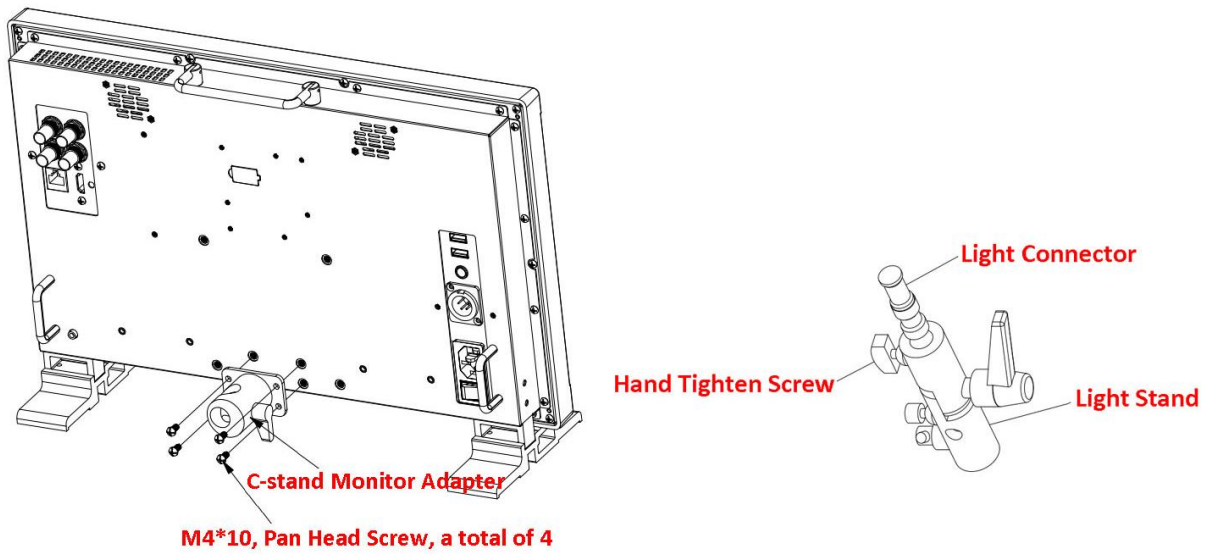

Figure 5.2-14 Adapter C-Stand to LCM-E Monitor

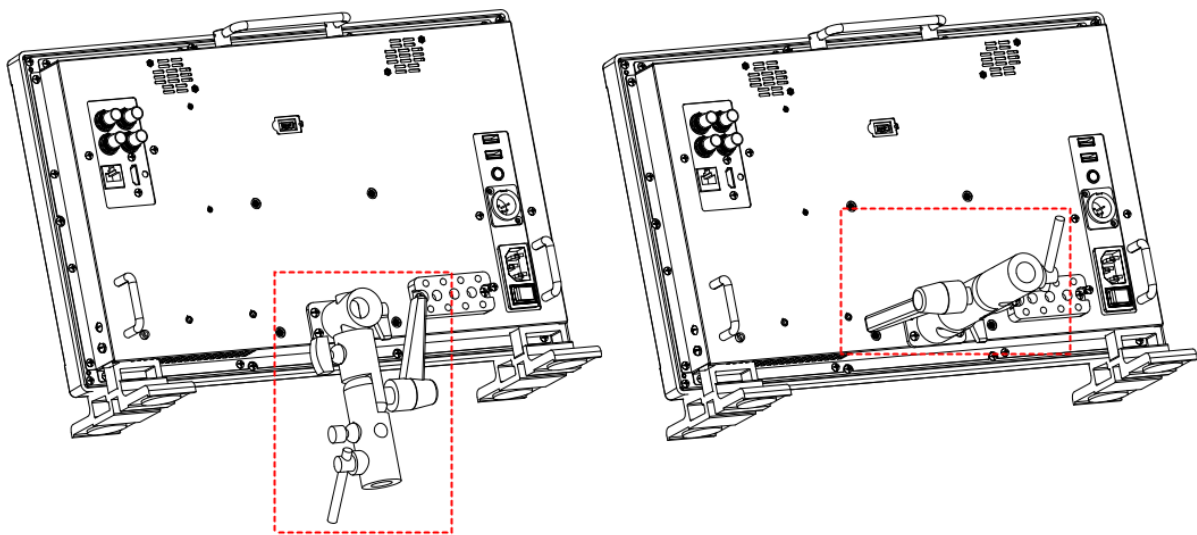

Figure 5.2-15 Connecting to Light Stand

5. Hanger

It provides an inch screw thread hanger as an optional accessory. The hanger provides two sorts of screw thread: 3/8 inch screw thread, a total of 4; 1/4 inch screw thread, a total of 8, as shown in Figure 5.2-16:

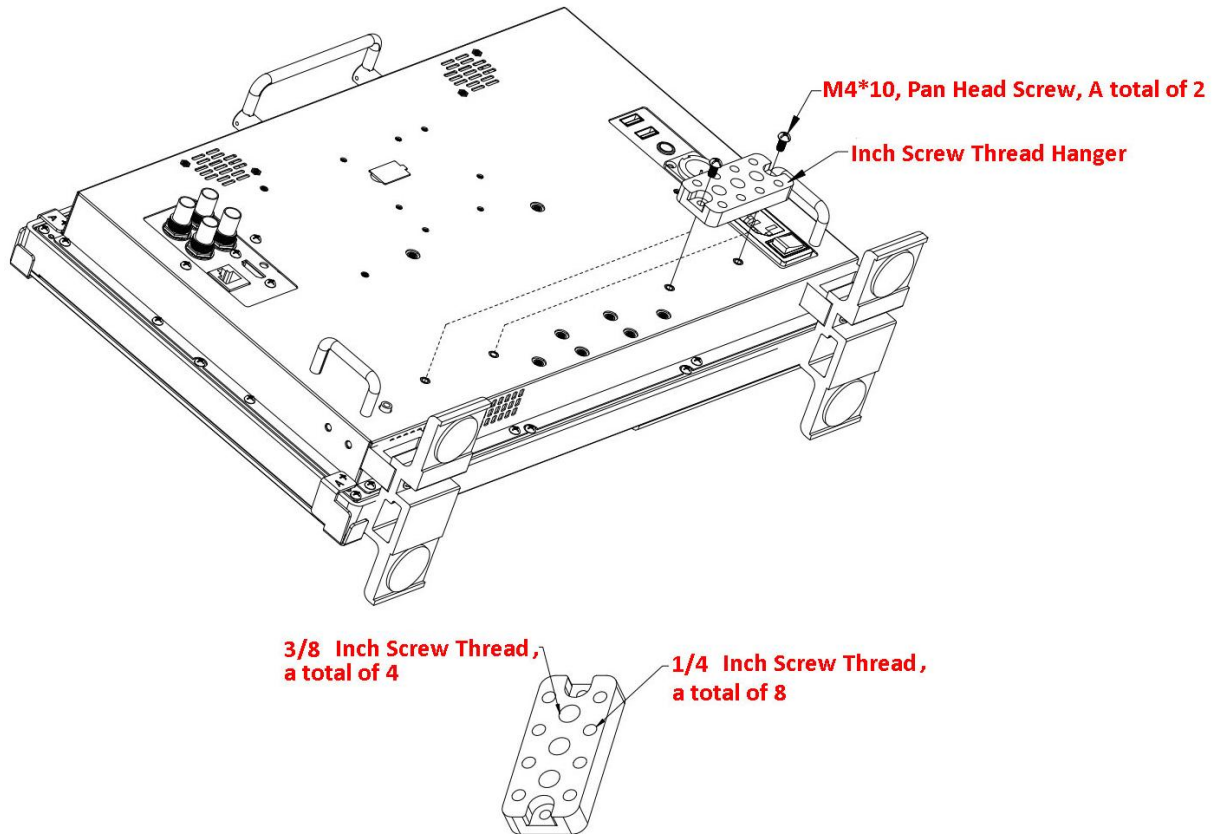

Figure 5.2-16 Inch Screw Thread Hanger

5.3 Dimensions

The description of the LCM***-E series dimensions are as shown in the following figures(Unit: mm):

■ LCM156-E

Front Panel

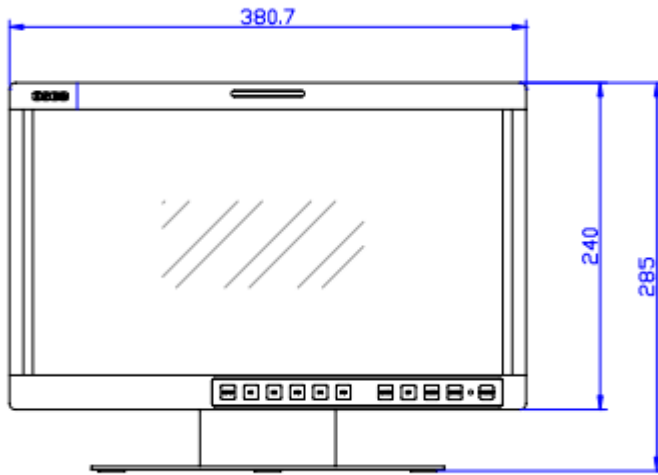

Side View

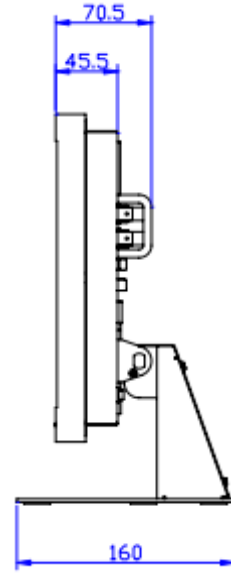

Rear Panel

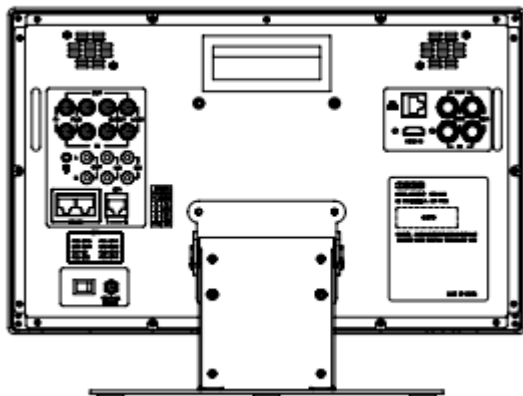

Top View

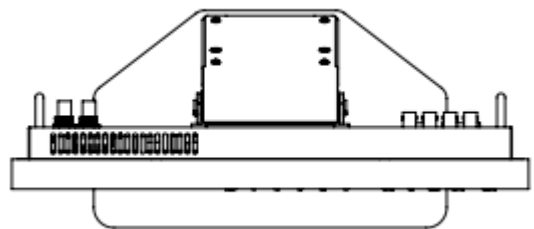

■ LCM170-E

Front Panel

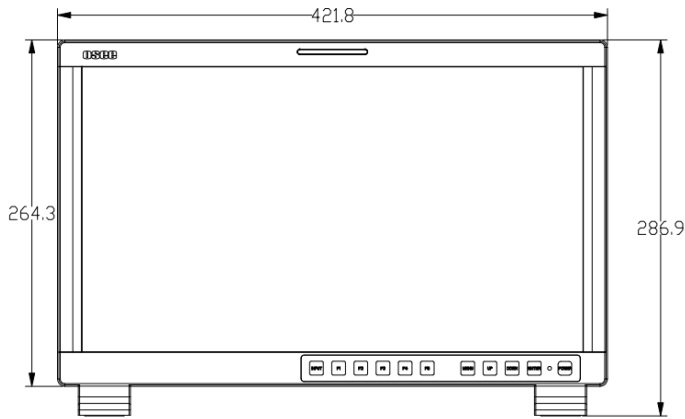

Side View

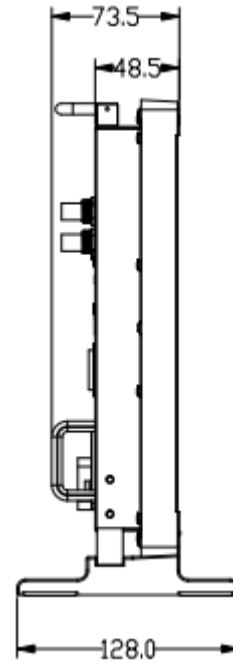

Rear Panel

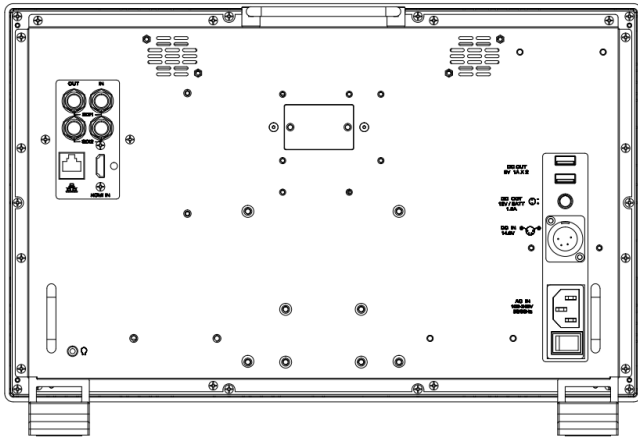

Top View

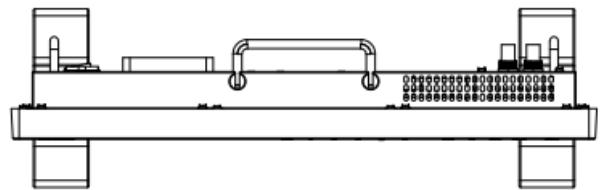

■ LCM215-E

Front Panel

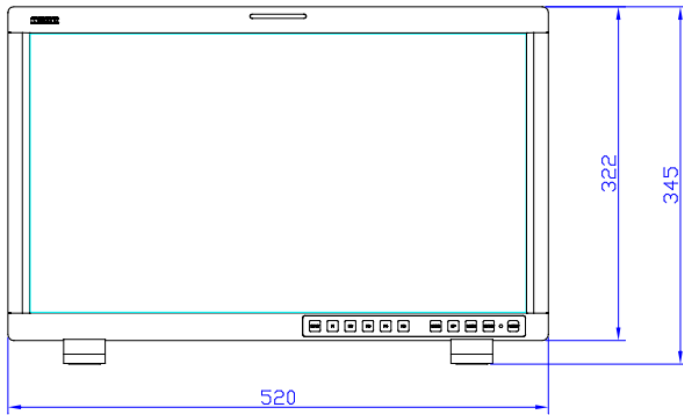

Side View

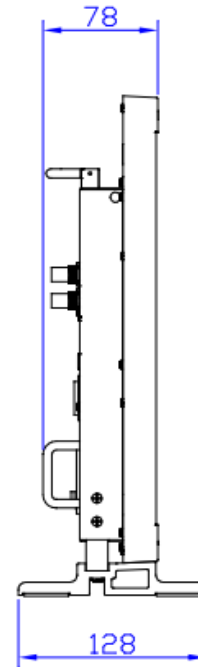

Rear Panel

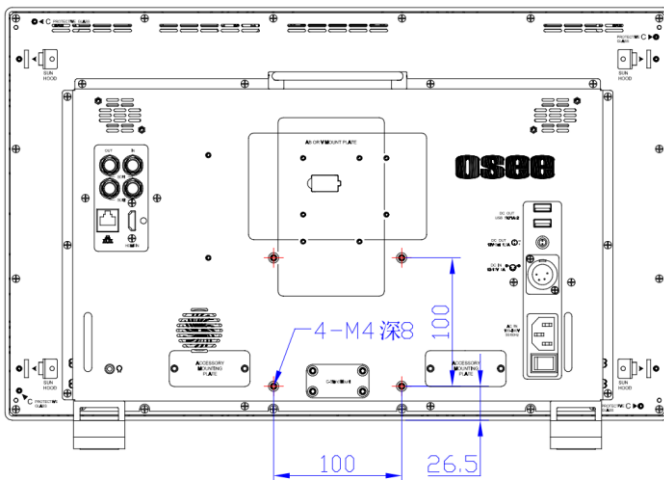

Top View

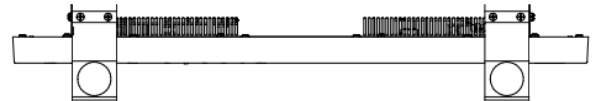

■ LCM230-E

Front Panel

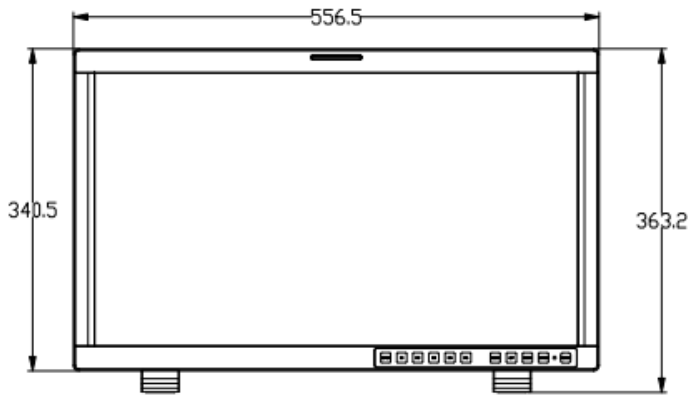

Side View

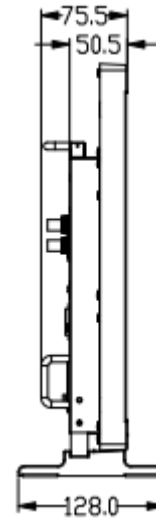

Rear Panel

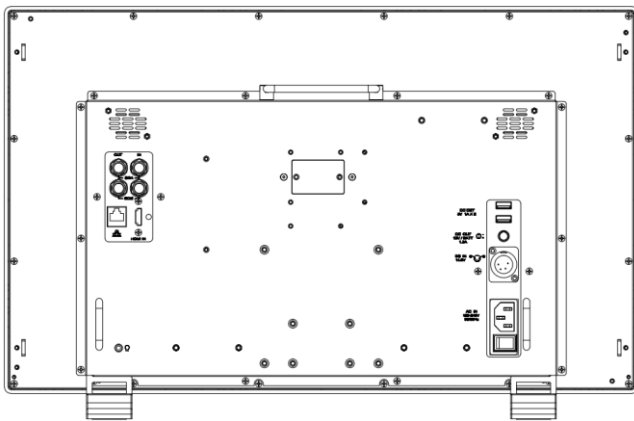

Top View

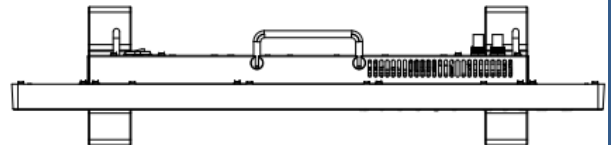

■ LCM240-E

Front Panel

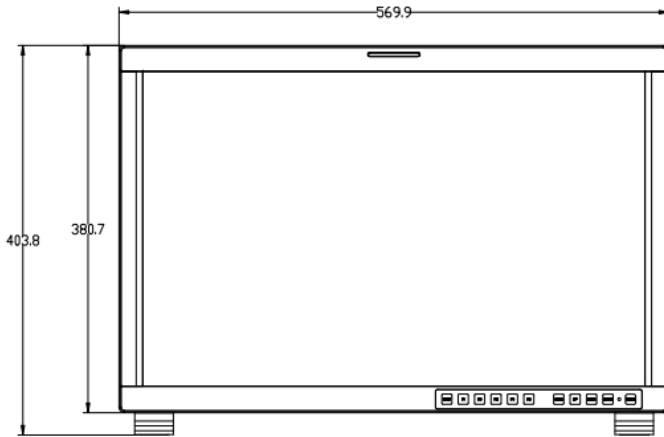

Side View

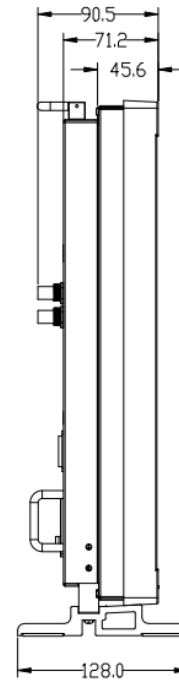

Rear Panel

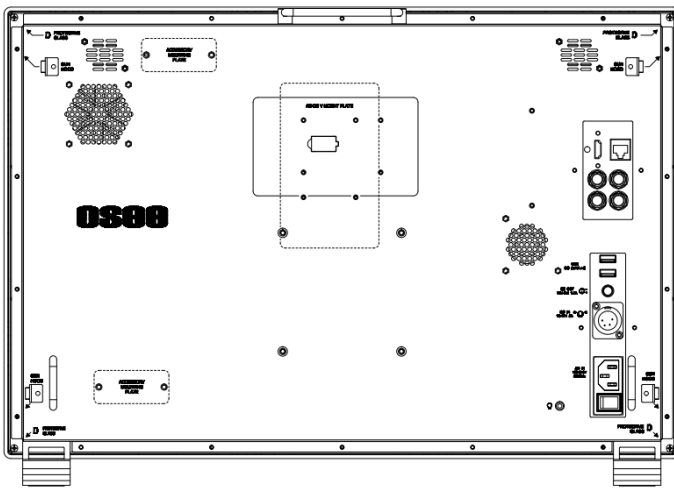

Top View

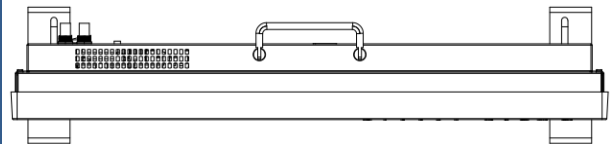

i Tips

- Specifications are subject to change without notice.

-----No Text Below-----



FOR MORE INFORMATION PLEASE VISIT: <http://www.osee-dig.com/>

OSEE TECHNOLOGY LTD.

Address: No.22 Building, No.68 zone, Beiqing Road, Haidian District,
Beijing, China

Tel: (+86) 010-62434168

Fax: (+86) 010-62434169

FOR MORE INFORMATION PLEASE VISIT: <http://www.oseeamericas.com>

OSEE AMERICAS, LTD.

Address: 43218 Christy Street Fremont, CA. 94538

Tel: (+1) 510-996-4499

E-mail: info@oseeamericas.com