

## 4 IN 1 Camera

# KTC-MBN6412x

- Sony 1/2.9" 2.19MP Progressive Scan CMOS
- 1080p(1920x1080)@30(25)fps
- 4in1 Output(AVI, TVI, CVI, CVBS)
- C/CS Mount for lens
- Mechanical Day&Night
- WDR, 3D DNR, Defog
- UTC function supports OSD Control
- Box Camera

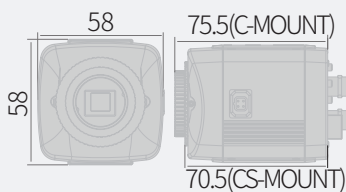

4 IN 1 Camera

# KTC-MBN6412x

## Dimensions

Unit:mm

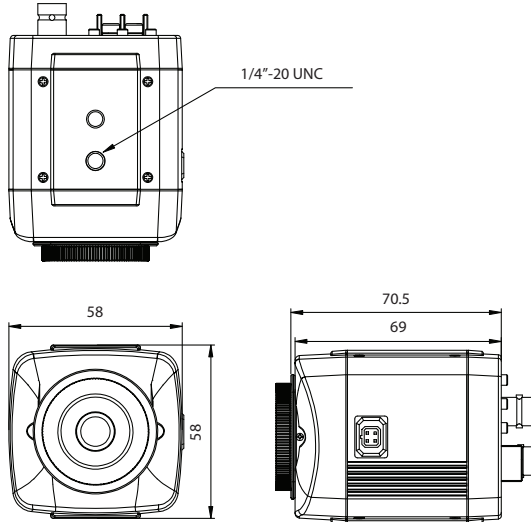

## Specifications

<b>Image Sensor</b>	1/2.9" Progressive Scan CMOS	<b>Privacy Mask</b>	16 Zones	
<b>Effective Pixels</b>	1985(H) x 1105(V)	<b>Image Rotation</b>	OFF/H-FLIP/V-FLIP/HV-FLIP	
<b>Max. Video Resolution</b>	TVI, AVI, CVI : 1080p@30(25)fps/ 720p@60fps(50fps)/720p@30fps(25fps) TV out: CVBS NTSC/PAL	<b>Defog</b>	OFF/ON(AUTO/MANUAL)	
<b>Type</b>	C/CS Mount lens	<b>Sharpness</b>	0~10	
<b>Lens Focal Length</b>	Depend on lens	<b>OSD control</b>	Rear OSD button, UTC	
<b>Angle of View</b>	Depend on lens	<b>Language</b>	ENGLISH,Русский, ESPAÑOL, DEUTSCH, FRANCAISE, PORTUGUÊS, 日本語, 한국어	
<b>Min.Illumination</b>	0.05Lux(F1.2, ICR OFF, AGC33dB, DSS:x2)	<b>Video Output mode</b>	AVI, TVI, CVI, CVBS	
<b>IR LEDs</b>	-	<b>General</b>		
<b>IR Range</b>	-	<b>IP Rating</b>	-	
<b>White Balance</b>	AUTO/AUTO EXT/PUSH LOCK/MANUAL	<b>Operating Temperature</b>	-10°C~+50°C	
<b>Dynamic Range</b>	<b>WDR/BLC</b>	OFF/BLC/HLC/WDR(4 Zones selectable)	<b>Storage Temperature</b>	-20°C~+60°C
	<b>D-WDR</b>	OFF/LOW/MIDDLE/HIGH	<b>Dimension(mm)</b>	58X58X70.5mm
	<b>Level</b>	132.6dB	<b>Weight</b>	Approx.180g
<b>Electronic Shutter Speed</b>	AUTO/FLICKER/MANUAL/(1/30(25)~1/30,000)	<b>Power Source</b>	12VDC(±10%)	
<b>Digital Slow Shutter(DSS)</b>	OFF~ x32	<b>Power Consumption</b>	Max.140mA@12VDC	
<b>Auto Gain Control(AGC)</b>	OFF~45dB	<b>Option</b>		
<b>Day&amp;Night</b>	AUTO/COLOR/B&W (Electronic D&N)	<b>Power Source</b>	DUAL POWER(24VAC/12VDC)	
<b>Noise Deduction</b>	3D-DNR(OFF/LOW/MIDDLE/HIGH)	<b>Power Consumption</b>	24VAC(±10%), Max.2.7W 12VDC(±10%), Max.190mA	
<b>Motion Detection</b>	OFF/ON(4 Zones)	<b>Lens</b>		