

Digital video camera

Equipped with the Global Shutter

Polarization CMOS Sensor

XCG-CP Series Polarization Camera

XCG-CP510 is innovative camera incorporating the newly developed 5.1 MP global shutter pixel-level polarization CMOS sensor.

Polarsens

Pregius

Exmor

GIGAVISION

PoE support



Features

Capture a polarized image with one shot

Each individual pixel has one of four different linear polarization filters which enables four different polarization images to be captured simultaneously. Each calculation unit composed of four-pixel block supports calculation of "Polarization directions" and "Degree of Polarization (DoP)" based on luminance value on each pixel.

Feature-rich

The SDK for polarization camera enables the following polarized image processing.

- Degree of Polarization (DoP)
- Direction of Polarization (Surface Normal)
- Reflection Removal
- Reflection Enhancement
- Stress, Distortion (Retardation).

Work efficiency

- The SDK for polarization camera enables easy Polarization application development.
- Sony provides a viewer application, library, and sample source code.

XCG-CP510 (B/W)

- 2/3-type Polarization Image CMOS Sensor with Global Shutter Function (Pregius)
- 5.1MP 23 fps

XPL-SDKW

- SDK for polarization camera (for Windows)

The On-Chip Polarizer features a four-directional polarizer formed on the photodiode of the image sensor which allows the detection of linear angles of polarized light. Combined with a unique SDK (XPL-SDKW), developed to facilitate the polarization process, users can easily enable contrast enhancement, object recognition, scratch detection, reflection removal, and stress and distortion inspection.

Polarization Camera
XCG-CP510

Four directional polarization signals

Polarizer image



SDK for Polarization Camera
XPL-SDKW

Polarization processing based on polarization signals

SDK

What is polarization?

Light is a vibrating electromagnetic wave that has four components; amplitude, wavelength, vibration direction, and radio wave direction. Of these components, Sony polarization technology focuses on vibration direction.

Unpolarized light

Normally, natural light, fluorescent light, and other kinds of light vibrate in random directions. Such light is called "natural light" or "unpolarized light" (Figure A).

Polarized light

Light vibrates in specific directions when it is reflected off the surface of an object. Such light is called "polarized light."

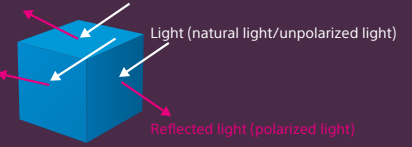

Figure A

Passing light through a polarization plate can remove or extract light in specific vibration directions. Passing natural light (unpolarized light) through a polarization plate can extract light polarized in specific directions (Figure B).

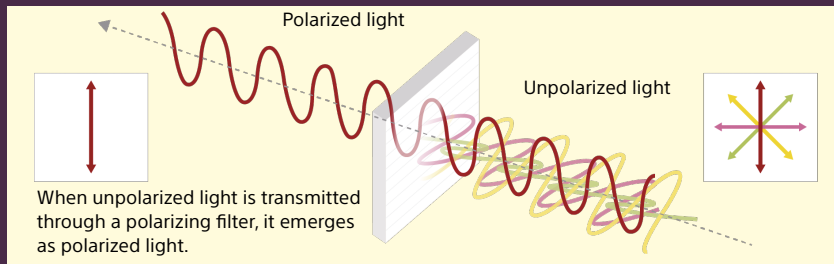

Figure B

Using the polarization phenomenon above, the shape of a subject can be estimated by analyzing luminance information from multiple images that have passed through polarization plates at different angles.

Polarization camera XCG-CP510

Capture four directions of the polarization.

Capturing four-pixel block polarized images through linear polarizing filters (0 deg, 45 deg, 90 deg, 135 deg) without a parallax issue.

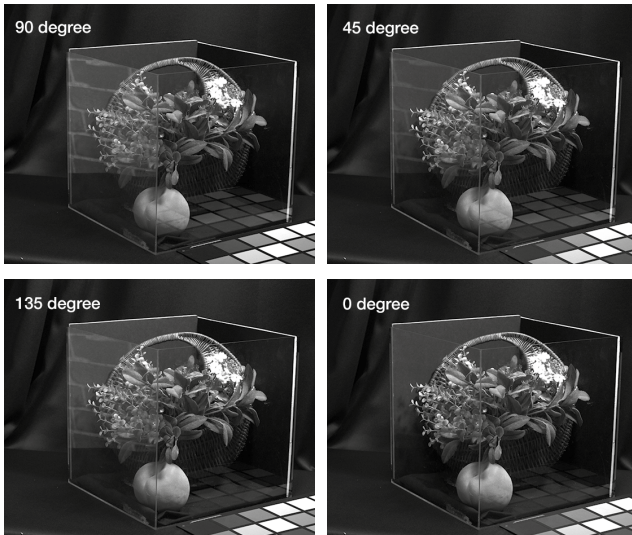
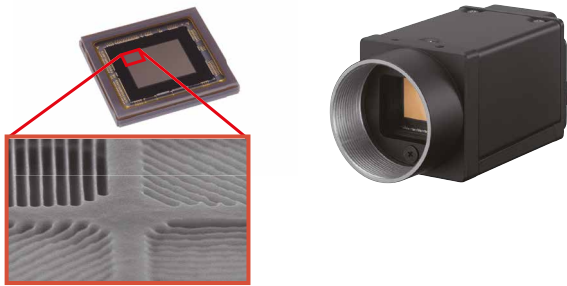

SDK for Polarization camera (for Windows) XPL-SDKW

Process each polarization application by using polarization signals.

The Windows SDK, provides versatile polarization functions such as reflection removal, shape recognition, and stress measurement by calculating polarization direction and/or Degree of Polarization (DoP) based on an image captured by the Polarization camera.

SDK for Polarization

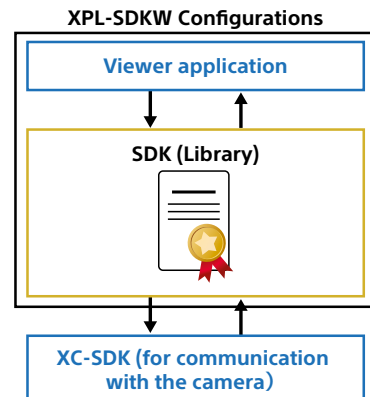

Applications of Polarization Cameras and SDK <Processing examples>

Degree of Polarization (DoP)

The degree of polarization (DoP) is calculated for each pixel and displayed as a degree of polarization image. This feature makes it easier to see low-contrast objects or objects that are difficult to recognize when they are the same colour as the background.



[Input Image]

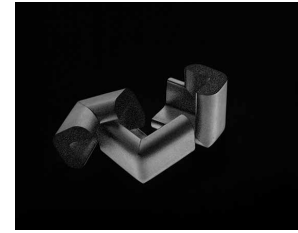

[DoP]

Direction of Polarization (Surface Normal)

The plane direction is estimated from the polarized state of each pixel and displayed as a surface normal image.

The object plane direction is divided into separate colours for an easy to differentiate display.

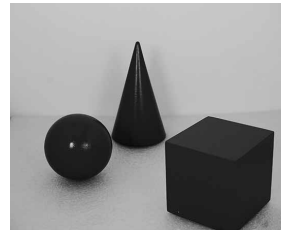

[Input Image]

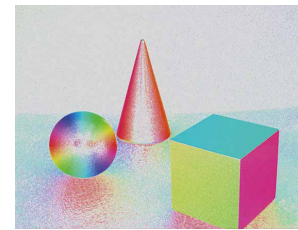

[Surface Normal]

Retardation

This indicates the direction and whether or not there is any distortion when light passing through the polarizing plate has passed through a transparent or semitransparent object.

The measurement is effective for checking the distortion when passing through transparent or semitransparent objects such as glass and for checking stress.

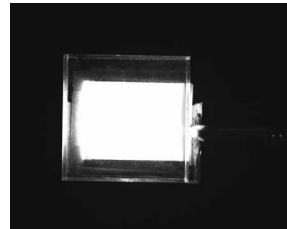

[Input Image]

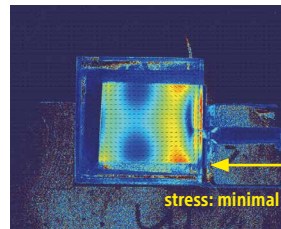

stress: minimal

[Retardation]

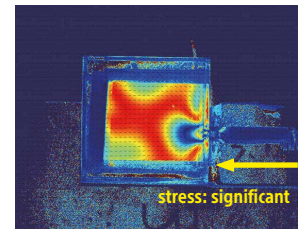

stress: significant

Reflection (Enhance)

Reflected components calculated from four direction polarized images are enhanced.

Images reflected off transparent objects such as glass are enhanced when displayed.

A transparent object can also be made more visible.



[Input Image]



[Reflection (Enhance)]

Reflection (Cancel)

Reflected components calculated from four direction polarized images are removed.

Images reflected off transparent objects such as glass are reduced, making objects on the other side more visible.

Reflections can be removed by both automatic calculation and manual angle adjustment.



[Input Image]



[Reflection (Cancel)]

Demosaic

Our unique demosaic function is optimally designed for the polarizer array.

All polarization processing on this SDK applies demosaic processing to calculate and display images.

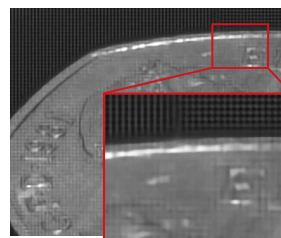

[Raw Image]

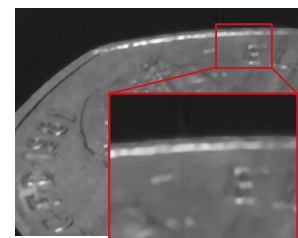

[After Demosaic]

* Expected results may not be obtained depending on measurement environments or conditions.

XCG-CP510 Specifications (Polarization Camera)

Basic Specifications		XCG-CP510
B/W / Colour		B/W
Image Size		5.1 MP
Image Sensor		IMX250 (Polarization image sensor) 2/3-type CMOS Image sensors with a global shutter function (Pregius)
Number of Effective Pixels (H x V)		2464 x 2056
Cell Size (H x V)		3.45 μm x 3.45 μm
Standard Output Pixels (H x V)		2448 x 2048
Frame Rate		23 fps (8 bit, Mono/Raw)
Minimum Illumination		1.5 lx (iris: F1.4, Gain: +18 dB, Shutter: 1/23 s)
Sensitivity		F4 (400 lx, Gain: 0 dB, Shutter: 1/23 s)
SNR		More than 50 dB (Lens close, Gain: 0 dB, 8 bit)
Gain		Auto, Manual: 0 dB to 18 dB
Shutter Speed		Auto, Manual: 60 to 1/100 000 s
Camera features		
Readout Modes		Normal, Partial scan
Readout Features		Test pattern
Synchronization		Hardware trigger, Software trigger, PTP (IEEE1588)
Trigger Modes		OFF (Free run), ON (Edge detection, Trigger width detection), Special trigger (Burst trigger, Bulk trigger, Sequential trigger, Free set sequence)
Userset		16
User Memory		64 bytes x 16 ch
Partial Scan	W (Pixel)	16 to 2,464
	H (Line)	16 to 2,056
GPO		EXPOSURE/Strobe/Sensor lead out/Trigger through/ Pulse generation signal/User defined 1, 2, 3 (selectable)
Other Features		Area gain, Defect correction, Shading correction, Temperature readout
Interface		
Video Data Output		digital Mono8, 10, 12 bit (default setting 8 bit)
Digital Interface		Gigabit Ethernet (1000BASE-T/100BASE-TX)
Camera Specification		GigEVision® Version 2.0/1.2
Digital I/O		ISO IN (x1), TTL IN/OUT (x2, selectable)
General		
Lens Mount		C mount
Flange Back		17.526 mm
Power Requirements		DC +12 V (10.5 V to 15.0 V), IEEE802.3af (37 V to 57 V)
Power Consumption		DC +12 V 3.3 W (max.)
		IEEE802.3af 3.7 W (max.)
Operating Temperature		-5 °C to +45 °C (23 °F to 113 °F)
Performance Guarantee Temperature		0 °C to 40 °C (32 °F to 104 °F)
Storage Temperature		-30 °C to +60 °C (-22 °F to +140 °F)
Operating Humidity		20% to 80% (no condensation)
Storage Humidity		20% to 80% (no condensation)
Vibration Resistance		10 G (20 Hz to 200 Hz 20 minutes for each direction -x, y, z)
Shock Resistance		70 G
Dimensions (W x H x D)		29 x 29 x 42 mm (1 3/16 x 1 3/16 x 1 11/16 inches) (excluding protrusions)
Mass		Approx. 65 g (2 oz)
MTBF		62,042 hours (Approx. 7.1 years)
Regulations		UL60950-1, FCC Class A, CSA C22.2-No. 60950-1, IC Class A Digital Device, CE: EN61326 (Class A), AS EMC: EN61326-1, VCCI Class A, KCC, CISPR22/24+IEC61000-3-2/-3
Supplied Accessories		Lens mount cap (1), Safety Regulations (1)

XPL-SDK Specifications (SDK for Polarization Camera)

	XPL-SDKW
Development language	C++ / C#
Development environment	Microsoft Visual Studio 2015, 2017
Functions	Degree of Polarization, Surface Normal, Stokes Vector, Retardation, Reflection, Online/ offline support, FFC (Flat Field Correction)
Configurations	Sample viewer application, Sample code, Library
Licensing	PC license
Recommended PC specs	
OS	Windows 7/8.1/10 (64bit)
CPU	Intel Core i7
Memory	16 GB or more
GPU	NVIDIA GeForce GTX1070 or above
Video RAM	8 GB or more
HDD/SDD	SSD 250 GB or more

Camera Functions

IEEE1588 compliant

Area Gain

Defect Correction

Shading Correction

Image Flip

Temperature Readout

Bulk Trigger

Burst Trigger

Sequential Trigger

Trigger Range

For details of each function, refer to the technical manual.

Dimensions

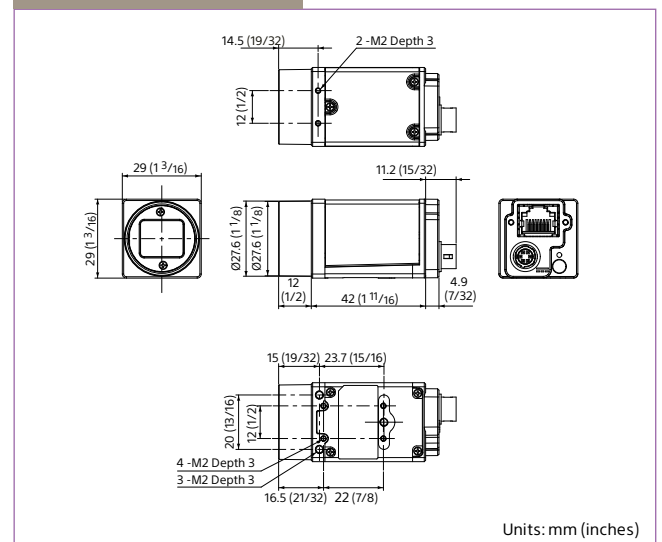

Distributed by

©2019 Sony Imaging Products & Solutions Inc. Reproduction in whole or in part without written permission is prohibited. Features and specifications are subject to change without notice. The values for mass and dimensions are approximate. SONY is a registered trademark of Sony Corporation. Polarsens, Pregius and Exmor are trademarks of Sony Corporation. All other trademarks are the property of their respective owners. Please visit Sony's professional website or contact your Sony representative for specific models available in your region.

PHC_19/02/2019

SONY