

CineEye II Pro

User Manual

*ACC*SOON

Product Features

High reliability dual band (2.4G and 5G) transmission

Transmission range of up to 1200 feet

Very low latency (<0.06 seconds)

HDMI in and HDMI loop out

High quality audio transmission

Supports transmission to up to 4 receivers

Camera Control supported

Professional monitoring App for iOS and Android

1.3 inch OLED display

DC and battery power supply supported

Firmware upgradable



Transmitter x1



Receiver x1

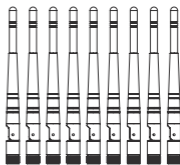

Antenna x9



User manual x1



Hot/Cold shoe mount adapter x2

CineEye 2 Pro

Transmitter

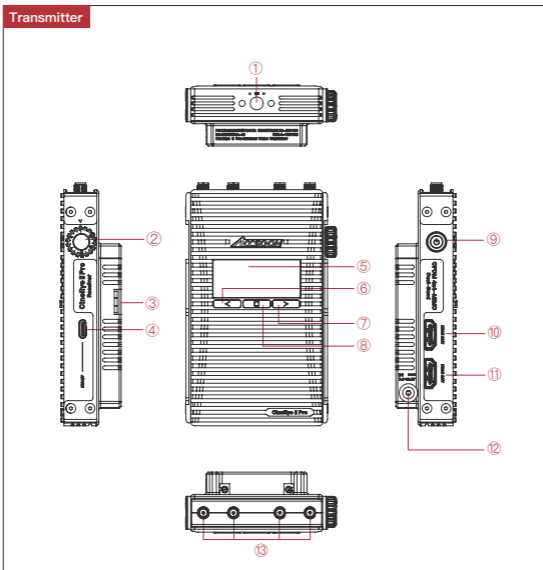

- ① 1/4 Screw ② Group Knob ③ Battery Lock ④ Camera Control Interface
- ⑤ 1.3 Inch OLED ⑥ Left Key ⑦ Right Key ⑧ Menu/OK Key
- ⑨ Power Button ⑩ HDMI Loop Out ⑪ HDMI In ⑫ DC Port
- ⑬ Antenna Connector (RP-SMA Male)

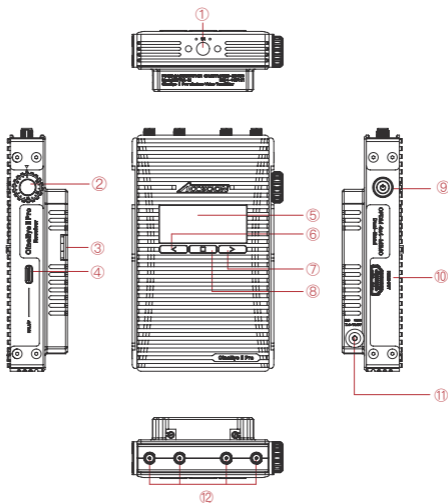

- ① 1/4 Screw ② Group Knob ③ Battery Lock ④ EXI-IF
- ⑤ 1.3 Inch OLED ⑥ Left Key ⑦ Right Key ⑧ Menu/OK Key
- ⑨ Power Button ⑩ HDMI Out ⑪ DC Port
- ⑫ Antenna Connector (RP-SMA Male)

Typical Application

Diagram 1

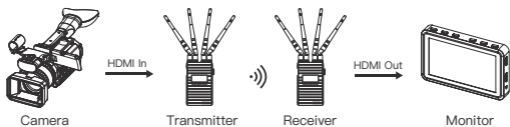
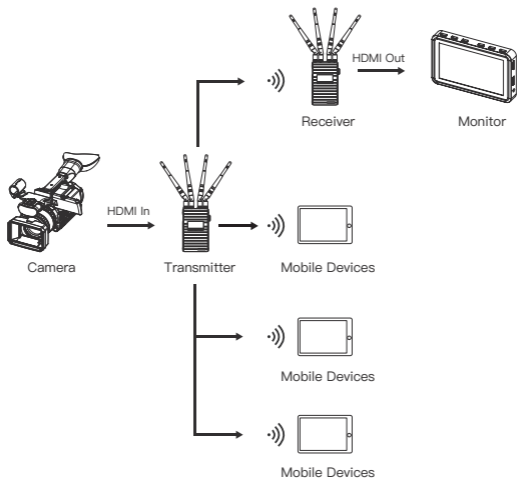
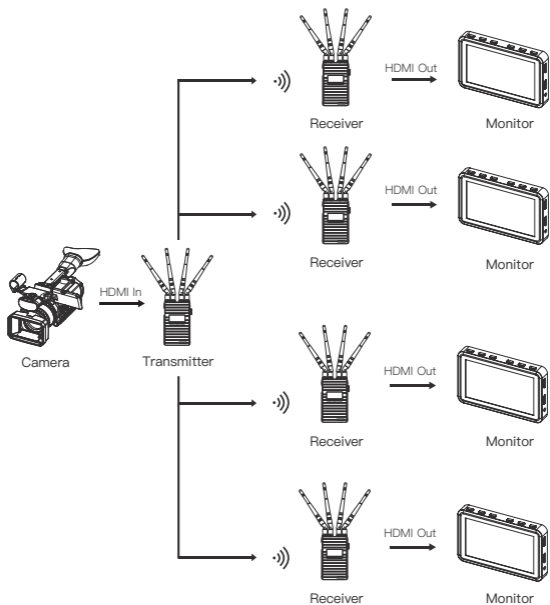

Diagram 2



Typical Application

Diagram 3



Operation Instructions

01 Install Instructions

1. Install the antennas as demonstrated.
2. Use the hot/cold shoe mount adapter to install the CineEye 2 Pro onto the camera or camera cage.
3. Use a NP-F970/F750/F550 battery or DC source to power the CineEye 2 Pro.
4. Connect camera output via HDMI to transmitter HDMI input port.
5. Connect receiver to the monitor (monitor not included in this product).

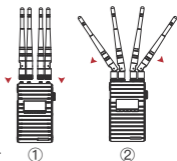

02 Turn On/Off

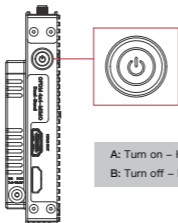

A: Turn on – Hold the power button for 1 seconds

B: Turn off – Hold the power button for 3 seconds

03 Group Settings

1. CineEye 2 Pro uses a group knob to pair the transmitter and receiver, both the transmitter and the receiver have a group knob on the side. The transmitter and receiver will pair automatically if their group knobs are in the same position (group number is the same), otherwise they will not pair and cannot communicate.
2. If users want to connect more than one receiver to the same transmitter, set all of the receiver's group numbers to the same as the transmitter. Up to four receivers can be paired to the same transmitter.
3. If multiple CineEye 2 Pro units are being used in the same area, each transmitter and receiver pairings needs to have a different group number.

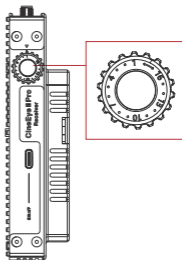

Note: If the group setting has changed, please bring the transmitter and receiver in close range, or the pairing may fall. If group setting has changed after power on, the change will take effect after reboot.

Operation Instructions

04 OLED Display

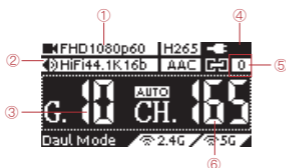

- ① Input video info
- ② Input audio info
- ③ Current group setting
- ④ Battery level/DC input
- ⑤ Connection status
- ⑥ Current 5G WiFi channel

Connection Status:

Transmitter: The connection status indicates how many devices are connected, if no devices are connected the unit will display “0”.

Receiver: The connection status will display “1” if the receiver is connected to a transmitter, or will display “0”.

05 Data Rate Setting

- ① High Quality Mode
- ② Normal Mode (Default setting)
- ③ Speed Mode

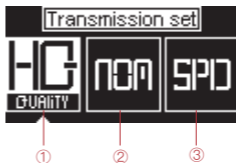

Setting steps:

Click the “Menu” button to enter “Data Rate Setting” → choosing a data rate mode → click “Menu” button to take effect.

Operation Instructions

06 Channel Setting

1. Only the transmitter has the “Channel Setting” menu.
2. The default setting is “Auto” which means the transmitter will select a channel with the least interference automatically after power on.
3. If users want to select a channel manually, please follow below steps: Click “Menu” button to enter “Channel Setting” menu->choosing a channel->click “Menu” button to confirm->Choosing “Yes” ->Click “Menu” button to reboot the transmitter and the setting will take effect.

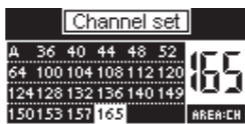

07 Network Reset

Only the transmitter has the “Network Reset” menu. Users can reset the WiFi SSID and password to factory settings by “Network Reset” menu.



Setting steps:

Click “Menu” button to enter “Network Reset” menu->choosing “Yes”->click “Menu” button to confirm->Choosing “Yes” ->Click “Menu” button to reboot, the SSID and password of the 5G WiFi will be reset to factory settings.

08 App Monitoring

1. App download

Please download the App (Accsoon Go) from the Google Play or iOS App Store.



2. Connect the App to the CineEye 2 Pro transmitter

Launch the “Accsoon Go” app and then select “CineEye 2 Pro”, open the WLAN (Wireless/WiFi) settings page of the mobile devices, then choose the CineEye 2 Pro WiFi and connect to it. The name of the CineEye 2 Pro WiFi is “CineEye2Pro_XXXX” and the default password is “12345678”.

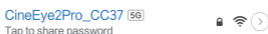

3. Monitoring

Return to Accsoon Go and ensure CineEye 2 Pro is selected, click “Monitor” to enter the monitoring page and you will be able to monitor the live feed of the camera.

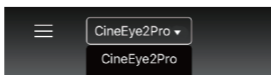

Note: CineEye 2 Pro has two WiFi signals, one is 2.4G and another is 5G, the 2.4G WiFi name is “CineEye2-Pro-GroupX”, please don’t connect to this WiFi.

09 Firmware Update

1. Firmware download

Make sure your mobile phone has internet access, then launch “Accsoon Go” and select “CineEye 2 Pro”, Click “Firmware Update”, then the App will check if there is an update. Click “Download” button to download the firmware if there is an update available.

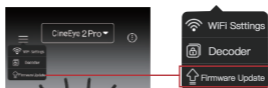

2. Update

After the firmware is downloaded, connect the CineEye 2 Pro receiver to the transmitter and then connect the mobile devices to the transmitter. Go back to the App and click “Next” to update.

- 1. The battery level of the CineEye 2 Pro should be above 50% before updating.
- 2. Don't turn off the CineEye 2 Pro before the updates are complete.

Specification

	Transmitter	Receiver
Video Input	HDMI	None
Video Output	HDMI	HDMI
Video Input Format	1080p 23.98/24/25/29.97/30/50/59.94/60fps 1080i 50/59.94/60fps 720p 50/59.94/60fps 480p 59.94/60fps	
Audio	44.1KHz/48KHz 16bit/24bit PCM	
Antenna Connector	4 RP-SMA Male	
Latency	<0.06 seconds(Camera latency not included)	
OLED	1.3 inch OLED	
Transmission Power	17~20dBm	
Transmission Range	1200 feet(no obstacles, no interference)	
Camera Control	Yes	None
Power Consumption	4.5 Watt (Typical)	5.5 Watt(Typical)
Operating Temperature	-10~40°C	
Dimensions	125mm×77mm×31mm(Antenna not included)	
Weight	Transmitter 225gram/Receiver 225gram(Antenna not included)	

01 Warranty Period

1. If there is a quality problem that occurs within 15 days after receiving the product, we will provide complimentary maintenance or replacement.
2. The warranty period for transmitter and receiver units is one year. Within the warranty period, if under the usage of instruction manual for any product problem Accsoon will offer repair service for free.
3. The accessories and cables warranty period is 3 months.

02 Warranty Exclusions

1. Unauthorized maintenance, misuse, impact damage, liquid infiltration, or modification.
2. Incorrect use of the product or altering the label and warranty sticker.
3. The warranty period has been exceeded.
4. Damage due to fire, flood, lightning, etc.

03 Warranty Process

Customer shall contact the local dealer to solve their problem. If there is no local dealer available, please contact Accsoon directly via email (support@accsoon.com) or our website (www.accsoon.com). You will get detailed information, and Accsoon reserves the right to review the damaged products.

01 Receiver cannot connect to transmitter

1. Please make sure the transmitter and receiver have the same group setting.
2. Please check that all antennas are tightened well.

02 No video displayed

1. Please ensure the HDMI cable is plugged into the "HDMI In" port of the transmitter
2. Please check if the output format of the camera is compatible with the CineEye 2 Pro input formats and check if the camera has video output enabled via the HDMI port.

03 Video is choppy

1. Please check if the antennas are tight.
2. Please make sure there is no cable around the antenna.
3. Please switch to another channel manually.

04 Mobile devices can't see the CineEye 2 Pro WiFi

1. Please check if your mobile devices support 5G WiFi.

05 Mobile devices can't connect to CineEye 2 Pro

1. CineEye 2 Pro has two WiFi networks available, one is 2.4G and another is 5G, the 2.4G WiFi name is "CineEye2-Pro-GroupX", please don't connect to this WiFi.



Website



Facebook



Youtube

Certificate of Quality

This product is confirmed to meet quality standards and permitted for sale after strict inspection.

QC Inspector: _____



More details about the product please visit www.accsoon.com

This document is subject to change without notice.

Accsoon® is a trademark of Accsoon Technology Co., Ltd.

Copyright ©2020 Accsoon. All rights reserved

