

# CineEye 2S

User Manual

ACCISON >

# Product Features

5GHz WiFi transmission

Transmission range of up to 500ft

Very low latency (<0.06 seconds)

SDI in and HDMI in

High quality audio transmission

Supports transmission to up to 4 receivers

Camera Control supported

Professional monitoring App for iOS and Android

1.3 inch OLED display

DC and battery power supply supported

Firmware upgradable



CineEye 2S x1



Hot/Cold shoe mount adapter x1



User manual x1

## CineEye 2S Diagram

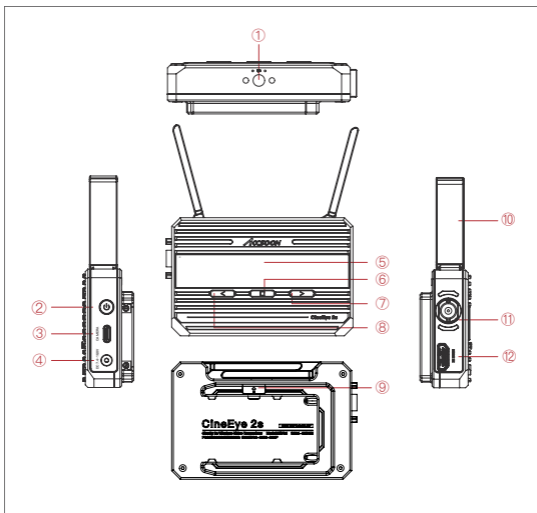

① 1/4 Screw

② Power Button

③ Camera Control Interface

④ DC Port

⑤ 1.3 Inch OLED

⑥ Menu/OK Key

⑦ Right Key

⑧ Left Key

⑨ Battery Lock

⑩ Antenna

⑪ SDI In

⑫ HDMI In

## Typical Application

Diagram

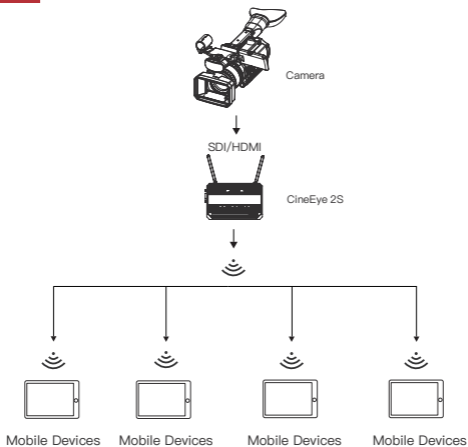

# Operating Instructions

## 01 Install Instructions

1. Unfold the antennas as demonstrated.
2. Use the hot/cold shoe mount adapter to install the CineEye 2S onto the camera or camera cage.
3. Use a NP-F970/F750/F550 battery or DC source to power the CineEye 2S.
4. Connect camera output to CineEye 2S SDI/HDMI input port.

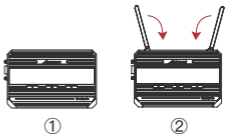

## 02 Turn On/Off

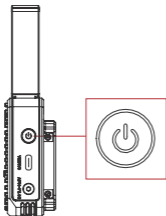

- Turn on – Hold the power button for 1 second
- Turn off – Hold the power button for 2 second

## 03 OLED Display

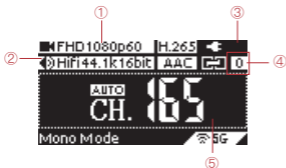

- ① Input video info
- ② Input audio info
- ③ Battery level/DC input
- ④ Connection status
- ⑤ Current 5G WiFi channel

### Connection Status:

The connection status indicates how many devices are connected, if no devices are connected the unit will display “0”.

# Operating Instructions

## 04 Data Rate Setting

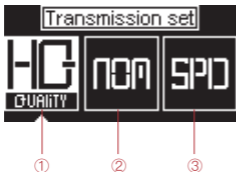

- ① High Quality Mode
- ② Normal Mode (Default setting)
- ③ Speed Mode

Setting steps:

Click the "Menu" button to enter "Data Rate Setting" -> choosing a data rate mode -> click "Menu" button to take effect.

## 05 Channel Setting

1. The default setting is "Auto" which means the transmitter will select a channel with the least interference automatically after power on.

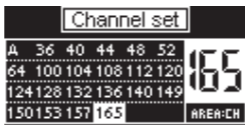

2. If users want to select a channel manually, please follow below steps: Click "Menu" button to enter "Channel Setting" menu -> choosing a channel -> click "Menu" button to confirm -> Choosing "Yes" -> Click "Menu" button to reboot the transmitter and the setting will take effect.

## 06 Network Reset

1. Users can reset the WiFi SSID and password to factory settings by “Network Reset” menu.



### Operation steps:

Click “Menu” button to enter “Network Reset” menu→choosing “Yes”→click “Menu” button to confirm→Choosing “Yes” →Click “Menu” button to reboot, the SSID and password of the 5G WiFi will be reset to factory settings.

## 07 App Monitoring

### 1. App download

Please download the App (Accsoon Go) from the Google Play or iOS App Store.



### 2. Connect the App to the CineEye 2S

Launch the “Accsoon Go” app and then select “CineEye 2S”, open the WLAN (Wireless/WiFi) settings page of the mobile devices, then choose the CineEye 2S WiFi and connect to it. The name of the CineEye 2S WiFi is “CineEye2\_XXXX” and the default password is “12345678”.

✓ CineEye2\_CC37





# Operating Instructions

## 3. Monitoring

Return to the Accsoon Go and ensure CineEye 2S is selected, click “Monitor” to enter the monitoring page and you will be able to monitor the live feed of the camera.

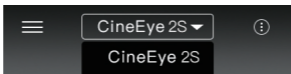

## 08 Firmware Update

1. Make sure your mobile phone has internet access, then launch “Accsoon Go” and select “CineEye 2S”, Click “Firmware Update”, then the App will automatically check if there is an update. The app will download the latest firmware automatically if there is an update available.

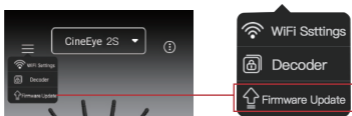

2. **Update:** After the firmware is downloaded, connect mobile devices to the CineEye 2S. Go back to the App and click the “Firmware Update” to update.



1. The battery level of the CineEye 2S should be above 50% before updating.
2. Don't turn off the CineEye 2S before the updates are complete.

# Specification

## CineEye 2S

Video Input	SDI/HDMI
SDI Input	1080p 23.98/24/25/29.97/30/50/59.94/60fps
HDMI	1080p 23.98/24/25/29.97/30/50/59.94/60fps 720p 50/59.94/60fps 480p 59.94/60fps
Audio	44.1KHz/48KHz 16bit/24bit PCM
Latency	<0.06 seconds ( Camera latency not included)
OLED	1.3 inch OLED
Transmission Power	17~20dBm
Transmission Range	500ft (no obstacles, no interference)
Camera Control	Yes
Power Consumption	4.0 Watt (Typical)
Operating Temperature	-10~40°C
Dimensions	108mm×68.5mm×30mm (Antenna not included)
Weight	213g

## 01 Warranty Period

- 1.If there is any quality problem that occurs within 15 days after receiving the product, we will provide complimentary maintenance or replacement.
- 2.The warranty period for transmitter and receiver units is one year. Within the warranty period, if under the usage of instruction manual for any product problem Accsoon will offer repair service for free.
- 3.The accessories and cables warranty period is 3 months.

## 02 Warranty Exclusions

- 1.Unauthorized maintenance, misuse, impact damage, liquid infiltration, or modification.
- 2.Incorrect use of the product or altering the label and warranty sticker.
- 3.The warranty period has been exceeded.
- 4.Damage due to fire, flood disaster, lighting, etc.

## 03 Warranty Process

- 1.Customer shall contact the local dealer to solve their problem. If there is no local dealer available, please contact Accsoon directly via email ([support@accsoon.com](mailto:support@accsoon.com)) or our website ([www.accsoon.com](http://www.accsoon.com)). Accsoon reserves the right to review the damaged products.

### 01 No video displayed

1. Please ensure the video cable is plugged into the "SDI IN" or "HDMI IN" port of the CineEye 2S.
2. Please check if the output format of the camera is compatible with the CineEye 2S input formats and check if the camera has video output enabled via the SDI or HDMI port.

### 02 Video is choppy

1. Please make sure the antennas have unfolded.
2. Please make sure there is no cable around the antenna.
3. Please switch to another channel manually.

### 03 Mobile devices can't see the CineEye 2s WiFi

1. Please check if your mobile devices support 5G WiFi.

## Contact Us



Website



Facebook



Youtube

### Certificate of Quality

This product is confirmed to meet quality standards and permitted for sale after strict inspection.

QC Inspector: \_\_\_\_\_



More details about the product please visit [www.accsoon.com](http://www.accsoon.com)

This document is subject to change without notice.

Accsoon® is a trademark of Accsoon Technology Co., Ltd.

Copyright ©2020 Accsoon. All rights reserved

