

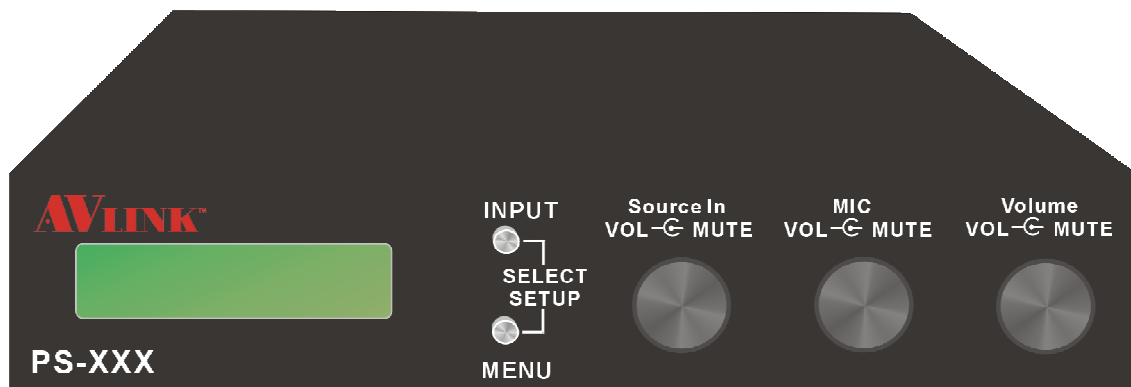

# User Manual



## Presentation Switcher

with HDMI solutions

3x1

**PS-301/301M**

V.2016PS-301Series.00

## **COPYRIGHT AND TRADEMARKS**

---

All rights reserved by C&C TECHNIC TAIWAN CO., LTD. No part of this document may be reproduced in any form or by any means without written permission from the product manufacturer. Changes are periodically made to the information in this document. They will be incorporated in subsequent editions. The product manufacturer may make improvements and /or changes in the product described in this document at any time.

All the registered trademarks referred to this manual are belonging to their respective companies.

## **BEFORE YOU BEGIN**

---

- Follow all instructions marked on the device during using.
- Provide proper ventilation and air circulation and do not use near water.
- It is better to keep it in a dry environment.
- Place the device on a stable surface (example cart, stand, table, etc.).
- The system should be installed indoor only. Install either on a sturdy rack or desk in a well-ventilated place.
- Make sure the rack is level and stable before extending a device from the rack.
- Make sure all equipments installed on the rack including power strips and other electrical connectors are properly grounded.
- Only use the power cord supported with the device.
- Do not use liquid or aerosol cleaners to clean the device.
- Always unplug the power to the device before cleaning.
- Unplug the power cord during lightning or after a prolonged period of non-use to avoid damage to the equipment.
- Do not stand on any device while installing the device to the rack.
- Do not attempt to maintain the device by yourself, any faults, please contact your vendor.
- Save this manual properly for future reference.

# TABLE OF CONTENTS

---

Copyright and Trademarks.....	1
Before You Begin.....	2
Table of Contents.....	3
Table of Figures.....	4
Chapter 1 Switcher System Overview.....	5
1.1 Introduction.....	5
1.2 Packing.....	6
Chapter 2 Features.....	7
Chapter 3 Specifications.....	8
Chapter 4 Front/Rear Panels.....	9
4.1 Front Panel.....	9
4.2 Rear Panel.....	11
Chapter 5 Connections.....	14
5.1 Input Connections.....	16
5.2 Output Connections.....	16
5.3 Multiple Connections.....	17
5.4 Remote Control Connection.....	17
5.5 IR Pass-Through Connection.....	18
5.6 Power Connection.....	18
5.7 I/O Ports.....	19
5.7.1 RS232.....	19
5.7.2 HDBT.....	20
5.7.3 Output Cable.....	21
Chapter 6 Troubleshooting.....	23
Appendix A HDBaseT Firmware Upgrade.....	25
A-1 HX-SRUW HDBaseT F/W Upgrade.....	25
A-2 Switcher HDBaseT F/W Upgrade.....	27
Appendix B Extender.....	31
B-1 Features.....	32
B-2 Specifications.....	33
B-3 IR Receiver Cable Directions.....	34
B-4 IR Blaster Cable Directions.....	34
B-5 HDMI Output Connector.....	34
B-6 Wiring Information for Link Connector.....	35
Appendix C Extend Audio Amplifier.....	36
C-1 Specifications.....	36
C-2 Audio Amplifier Connection.....	37

## TABLE OF FIGURES

---

Figure 1-1 PS-301/PS-301M Switcher .....	5
Figure 4-1 PS-301/PS-301M Switcher Front Panel .....	9
Figure 4-2 PS-301 Switcher Rear Panel.....	11
Figure 4-3 PS-301M Switcher Rear Panel .....	11
Figure 4-4 RS232 Pin Definitions.....	11
Figure 4-5 IR Blaster/Receiver Pin Definitions .....	12
Figure 4-6 SPDIF Ports .....	12
Figure 5-1 PS-301 Connections.....	14
Figure 5-2 PS-301M Connections.....	15
Figure 5-3 Input Connections .....	16
Figure 5-4 Output Connections .....	16
Figure 5-5 RS232 and Control PC connection .....	17
Figure 5-6 IR Extended Connection .....	18
Figure 5-7 Power Connection .....	18
Figure 5-8a RS232 Pin Function.....	19
Figure 5-8b RS232 Pin Function.....	19
Figure 5-8c RS232 Pin Function.....	20
Figure 5-9 LAN (HDBT) Port.....	20
Figure 5-10 Output LAN Cable.....	21
Figure A-1 HX-SRUW F/W Upgrade 1 .....	25
Figure A-2 HX-SRUW F/W Upgrade 2.....	26
Figure A-3 HX-SRUW F/W Upgrade 3.....	26
Figure A-4 HX-SRUW F/W Upgrade 4.....	27
Figure A-5 Switcher HDBase T F/W Upgrade 1 .....	27
Figure A-6 Switcher HDBase T F/W Upgrade 2 .....	28
Figure A-7 Switcher HDBase T F/W Upgrade 3 .....	28
Figure A-8 Switcher HDBase T F/W Upgrade 4 .....	29
Figure A-9 Switcher HDBase T F/W Upgrade 5 .....	29
Figure A-10 Switcher HDBase T F/W Upgrade 6.....	30
Figure A-11 Switcher HDBase T F/W Upgrade 7 .....	30
Figure B-1 HX-SRUW Extender.....	31
Figure B-2 IR Receiver Cable.....	34
Figure B-3 IR Blaster Cable .....	34
Figure B-4 HDMI Output Connector .....	34
Figure B-5 RJ-45 Pin Assignment.....	35
Figure C-1 Extend Audio Amplifier.....	36
Figure C-2 Audio Amplifier Connection .....	37

## CHAPTER 1 SWITCHER SYSTEM OVERVIEW

### 1.1 Introduction

The Presentation Switcher is a high performance, zero-second latency switching equipment with simple 3x1 transmission interfaces. It is a switcher and also a converter means that it can handle virtually video/audio signals on its 3 HDMI inputs (PS-301) or 1 HDMI/1 VGA inputs (PS-301M). Split the HDMI signal and mix with the audio signal comes from the MIC input interface integrated the optical SPDIF or R/L stereo audio output signal. (R/L feature is only for PS-301M) The built-in converter handles analog to digital conversion, as well as the signals conversion is virtually converted to any output equipments including any projector, TV or other audio amplifier. Built-in extender interfaces allowing you to integrate external extensible accessory devices to transmit data or to over long distances up to 70 meters.

The Switcher can be controlled in some ways; the front panel offers input/output selection and audio configured control, as well as an IR extender connected to rear panel for user to control the PS-301 series with an IR controller.

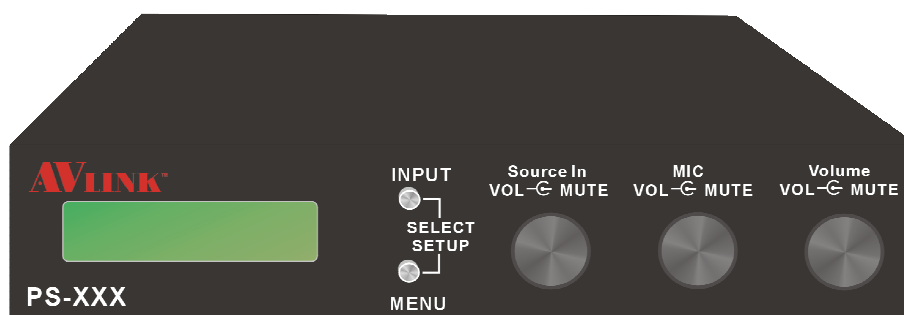





Figure 1-1 PS-301/PS-301M Switcher

## 1.2 Packing

 A black rectangular device with a green display screen on the left. The screen shows "PS-XXX". To the right of the screen are four buttons labeled "SELECT", "SET", and two unlabeled buttons. Above the buttons are labels: "INPUT", "MODE", "MODE", and "MODE".	PS-301/PS-301M Switcher *1
 A black power cord with a standard three-prong AC power plug on one end and a smaller, rectangular connector on the other.	Power Cord *1
 A black serial cable with a DB9-F connector on one end and a 3.5mm connector on the other.	DB9-F to 3.5mm Serial Cable *1
 A simple icon of a document with horizontal lines representing text.	User Manual x 1

## CHAPTER 2 FEATURES

---

- 3 x HDMI In Up to 4K x 2K@30fps for PS-301, or 1 x HDMI In for PS-301M
- 1 x VGA In + 1 x 3.5Ø Stereo Audio Inputs Associated with Each VGA Connection (Only for PS-301M)
- 1 x YPbPr + R L RCA Connector Jack Audio Inputs (Only for PS-301M)
- 1 x Microphone Input (XLR Connector)
- MIC inputs can be provided up to +48V phantom power
- 1 x HDMI Output w/HDBaseT 70 Meters Output (Bypass Input Audio Only, None Microphone Mixer)
- Knob Adjustable for Source Volume, Microphone Volume, Main Audio OUT Volume. (Press Knob Once for Mute)
- Microphone “**Take-Over**” Mode to Mix the Microphone Signal w/ the Source Audio Independent L/R Output, Coaxial Output, and TOSTLINK SPDIF Output (Source Audio is from 3.5Ø Stereo Audio or De-embed from HDMI Source) (L/R feature is only for PS-301M)
- Support EDID Management
- LCD Display for Status Read Easily
- 2 x Front Panel Push buttons for Source Selection
- HDBaseT 70 Meters Output
- HDBaseT Technology, Use One CATx Cable to Install Easily
- Internal universal power supply
- 1U rack Unit Height



## CHAPTER 3 SPECIFICATIONS

Hardware	
LCD Module	1
Pushbuttons	2
Knob	3
Input Connector	PS-301: HDMI Type A x 3 PS-301M: HDMI Type A x 1/YPbPr x 1/VGA x 1
Output Connector	HDMI Type A x 1/RJ-45 x 1
IR IN	3.5Ø Phone Jack x 1
IR OUT	3.5Ø Phone Jack x 1
RS232	3.5Ø Phone Jack x 1
MIC Input	XLR Connector x 1
Audio Input	3.5Ø Phone Jack x 1/RCA Connector (R,L) x 1 set (Only for PS-301M)
Audio Output	Terminals Block (Differential) x 1 Digital Optical Toslink x 1 RCA Digital Audio x 1
LAN Connector	RJ-45
Power	100VAC~240VAC, 50/60Hz, internal
Housing	Aluminum/Metal
Mounting	1U Rack mountable
Weight	PS-301: 2290g PS-301M: 2353g
Dimensions (LxWxH)	220x350x44mm

### VGA Support Resolution:

VGA Input (Support Video Modes)	
60Hz	640*480, 800*600, 1024*768, 1152*864, 1280*600, 1280*720, 1280*768, 1280*800, 1280*960, 1280*1024, 1360*768, 1366*768, 1400*1050, 1440*900, 1600*900, 1600*1200, 1680*1050, 1920*1080
75Hz	640*480, 800*600, 1024*768, 1152*864, 1280*800, 1280*1024

### YPbPr Support Resolution:

YPbPr VGA Input (Support Video Modes)	
60Hz	640*480, 800*600, 1024*768, 1280*768, 1280*1024, 1360*768, 1600*900, 1600*1200, 1680*1050, 1920*1080
75Hz	640*480, 800*600, 1024*768, 1280*1024

## CHAPTER 4 FRONT/REAR PANELS

### 4.1 Front Panel

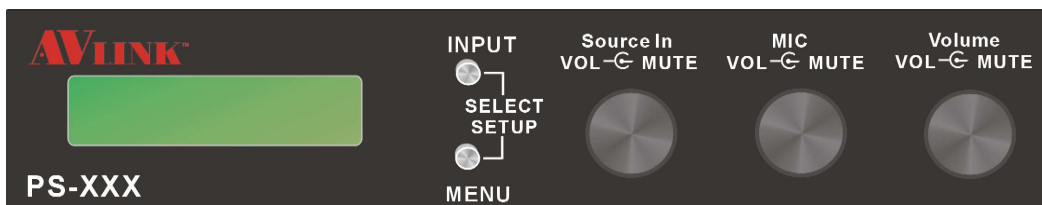

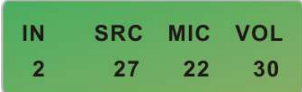

Figure 4-1 PS-301/PS-301M Switcher Front Panel

The Switcher supports 2 switching keys (Input\*1/Menu\*1) on the Front Panel. The keys allow you to configure the connected signal quickly and indicate the connection status clearly showing on the LCD display.

- **INPUT** key (input channel): Specifies the one of input channels that comes from HDMI 1~3, YPbPr + Audio R/L and VGA IN + Audio IN interface for output. You can also press this key to switch input channels. (YPbPr + Audio R/L and VGA IN + Audio IN are only for PS-301M)
- **MENU** key: Press this key to switch the configuration status showing on the LCD display.
- **Source In knob**: Adjusts the output volume. Press the knob once to mute the output and press again to restore the volume.
- **MIC knob**: Adjusts the MIC volume. Press the knob once to mute the MIC and press again to restore the volume.
- **Volume knob**: Adjusts the mixed audio volume. Press the knob once to mute the mixed audio and press again to restore the volume.

☞ You can adjust the volume level from value 0 (mute) to value 30 (max.).

- **LCD:** LCD display shows current switcher status and operation status. Press **Menu** key to switch the LCD display screen.

LCD Display	Description
	<p>* IN: Show you currently AUD OUT configuration is IN1~IN3.</p> <p><b>PS-301:</b>            IN1 → HDMI IN1            IN2 → HDMI IN2            IN3 → HDMI IN2</p> <p><b>PS-301M:</b>            IN1 → HDMI IN            IN2 → YPbPr + Audio R/L            IN3 → VGA IN + Audio IN</p> <p>* <b>SRC:</b> Specify the sound volume comes from connected input HDMI port. Value 0 means mute.</p> <p>* <b>MIC:</b> Specify the MIC volume.</p> <p>* <b>VOL:</b> Total output volume, namely the sound volume of mixed HDMI IN, Audio R/L and Audio IN. (Audio R/L and Audio IN are only for PS-301M)</p>
	<p>Specify you the types of microphones are LINE in or 48V phantom power.</p>
	<p>Show you the information both the best video and audio results come from input channels. And all of them will be held automatically within your switcher. <b>EDID Value: 720P, 1080P, HDMI and HDBT</b></p>

## 4.2 Rear Panel



Figure 4-2 PS-301 Switcher Rear Panel

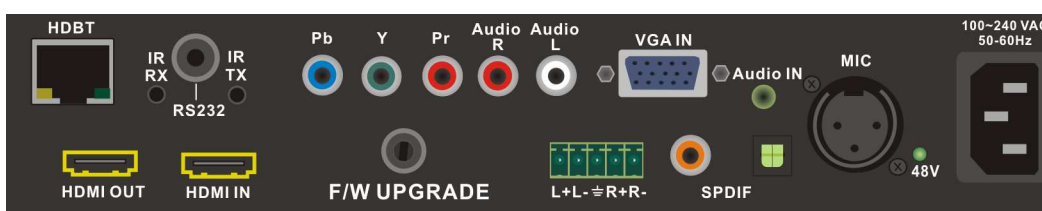

Figure 4-3 PS-301M Switcher Rear Panel

The Switcher supports input jacks (HDMI x 3 for PS-301 and HDMI\*1/VGA+Audio sets for PS-301M), MIC input port x1 and multiple output interfaces on the rear panel. The input interfaces allowing you to connect to different equipments including CD/DVD players, Blue Ray player, PS3, Video Camera, STB and so on. The HDMI output can be connected to projectors, video recorders, multiplexers and other displayers directly. Other output interfaces allowing you to connect to extensible accessory devices for over long connections with terminal display devices.

- **HDBT OUT (RJ45)** : The Switcher Output connector is connected to the A/V, HDTVs or other output devices via an extensible accessory device for over long connection.
- **RS232**: Through a 3.5mm to DB9 female RS232 cable for a long-distance serial data transmission.

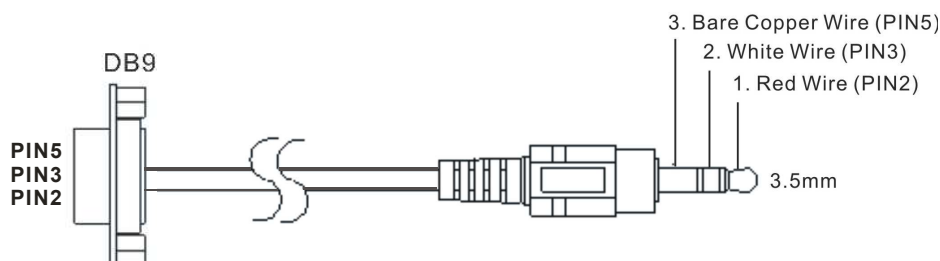

Figure 4-4 RS232 Pin Definitions

- **IR (RX/TX):** Through a IR Blaster/Receiver cable connection, you can extend the IR signals transmission between Switcher and Remote devices.

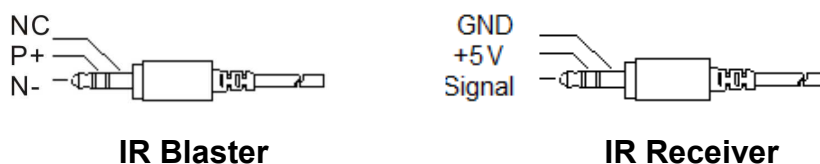

Figure 4-5 IR Blaster/Receiver Pin Definitions

- **HDMI OUT:** The Switcher Output connector is connected to the A/V, HDTVs or other output devices directly.
- **HDMI IN 1~3:** These ports receive the HDMI signals through a HDMI cable comes from the input sources.

**HDMI Type A Connector host assignment:**

Pin #	Signal	Pin #	Signal
1	TMDS Data2+	11	TMDS Clock Shield
2	TMDS Data2 Shield	12	TMDS Clock-
3	TMDS Data2-	13	NC
4	TMDS Data1+	14	NC
5	TMDS Data1 Shield	15	DDC-SCL
6	TMDS Data1-	16	DDC-SDA
7	TMDS Data0+	17	DDC-Ground
8	TMDS Data0 Shield	18	+5V Power
9	TMDS Data0-	19	Hot Plug Detect
10	TMDS Clock+		

- **YPbPr:** The **Pb**, **Y**, **Pr** ports are connected to the audio signal sources. (Only for PS-301M.).
- **SPDIF:** This port is connected to the audio output device. The Switcher supports the signal transmitted over either a coaxial cable with RCA connector or a fiber optic cable with Toslink connectors to keep the signal transmission fidelity in a short-distance.

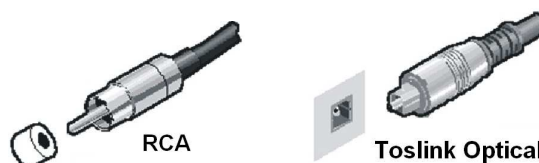

Figure 4-6 SPDIF Ports

- **Audio R/L:** The Switcher supports the stereo R/L audio input interface. (Only for PS-301M.).
- **L+L- GND R+R-:** The connector is used to connect the extender with audio amplifier.
- **VGA IN +Audio IN:** These ports receive the VGA and Audio signals through VGA and Audio cables come from the input sources. (Only for PS-301M.).

#### VGA Connector assignment:

Pin #	Signal	Pin #	Signal
1	Red	9	NC
2	Green	10	Sync return
3	Blue	11	NC
4	NC	12	Bi-directional data (SDA)
5	Return (GND)	13	Horizontal sync
6	Red return	14	Vertical sync
7	Green return	15	Data clock (SCL)
8	Blue return		

- **F/W UPGRADE:** Used to upgrade the firmware.
  - **MIC:** The Switcher supports the microphones connection.
  - **48V LED:** The Switcher supports the microphone with 48V phantom power. When you want to connect a 48V Condenser microphone, you can press the **MENU** key on the front panel to switch the LCD screen to microphone configuration screen. Once the connection is successful, the 48V LED indicator turns to solid green.
- ☞ When using a 48V microphone (phantom power), make sure the MIC connector on the rear panel of your Switcher is connected to a 48V microphone in order to avoid the damage to non-48V type of microphone.
- **Power port:** The Power Port is applicable for 100~240VAC, 50~60Hz connected to the outlet of power source. Refer to [5.6 Power Connection](#).

# CHAPTER 5 CONNECTIONS

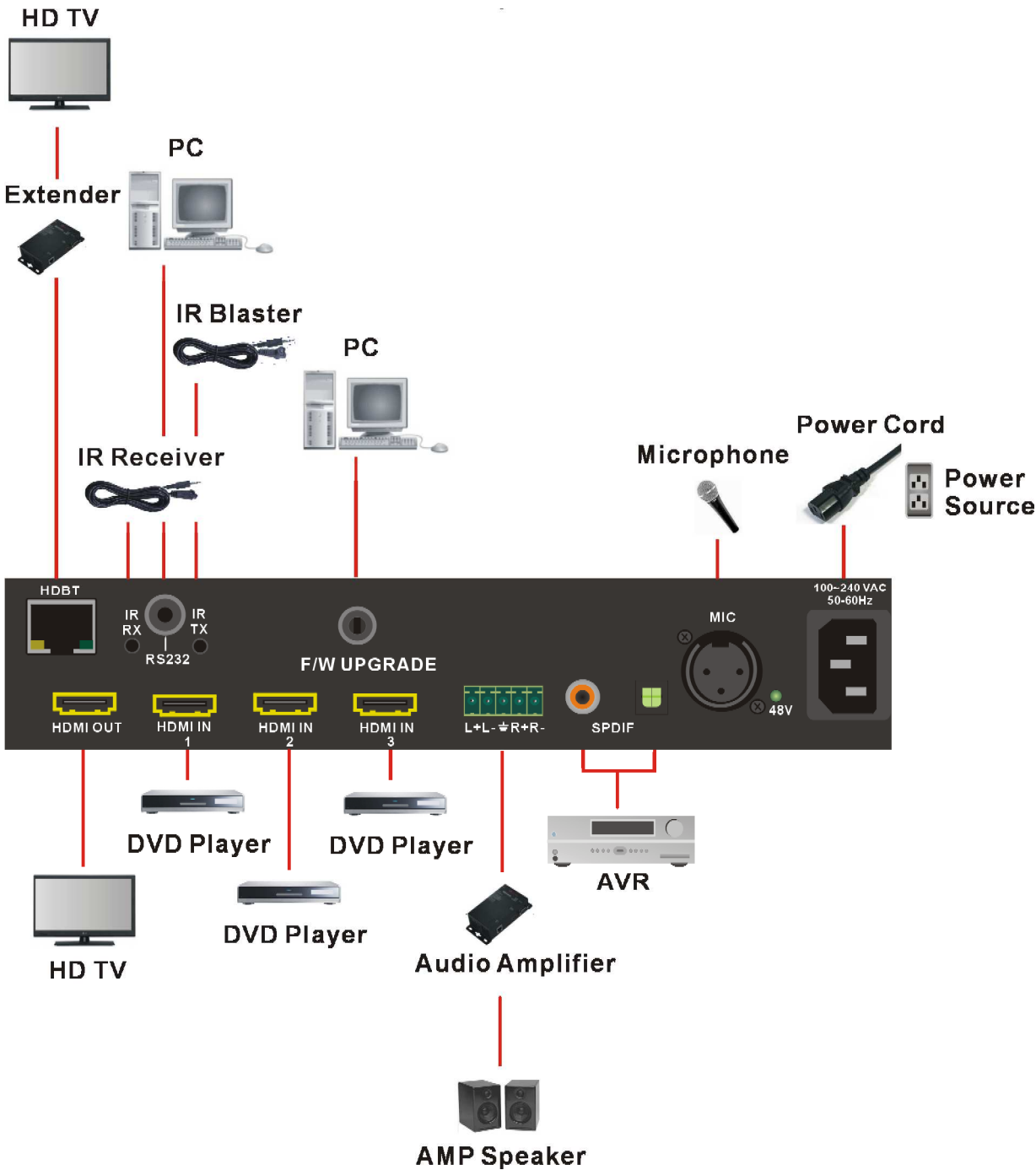

Figure 5-1 PS-301 Connections

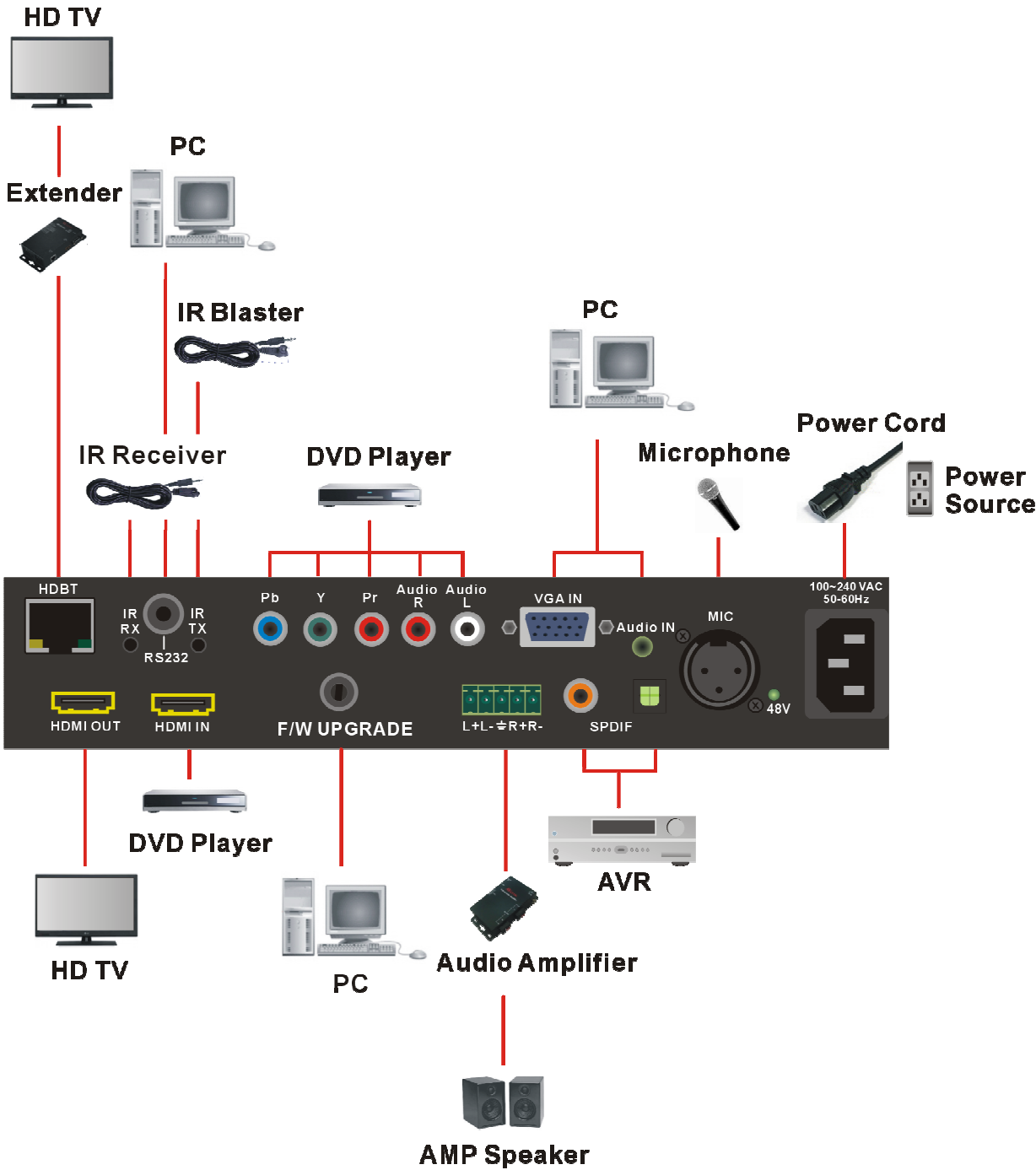

Figure 5-2 PS-301M Connections



## 5.1 Input Connections

Use the HDMI/VGA+Audio connecting cable to connect the Input serial jack (HDMI IN/ VGA IN/Audio IN) to the output source jack of the Blu-ray/DVD player displays/graphics workstations/PC.

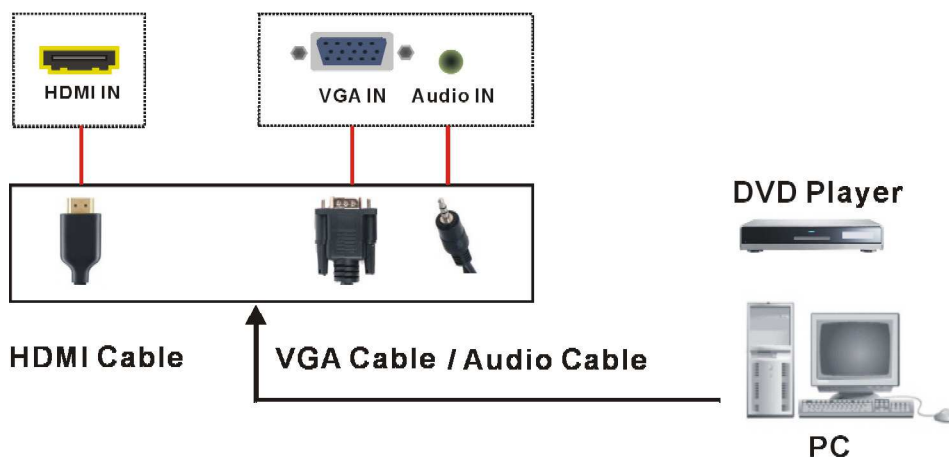

Figure 5-3 Input Connections

## 5.2 Output Connections

- Use the HDMI cable to connect the output jack (OUT1 ~ OUT2 with HDMI interface) on the rear panel to the input jack of the projector, video recorder, display, HD TV or multiplexer directly.
- Or use the Cat.5e cable to connect the output RJ-45 jack (OUT1 ~ OUT2 with RJ-45 interface) on the rear panel to the LINK IN jack of the Extender. Through the Extender, you can extend the transmission distance and over-long configuring the projector, video recorder, display or multiplexer to your Switcher.

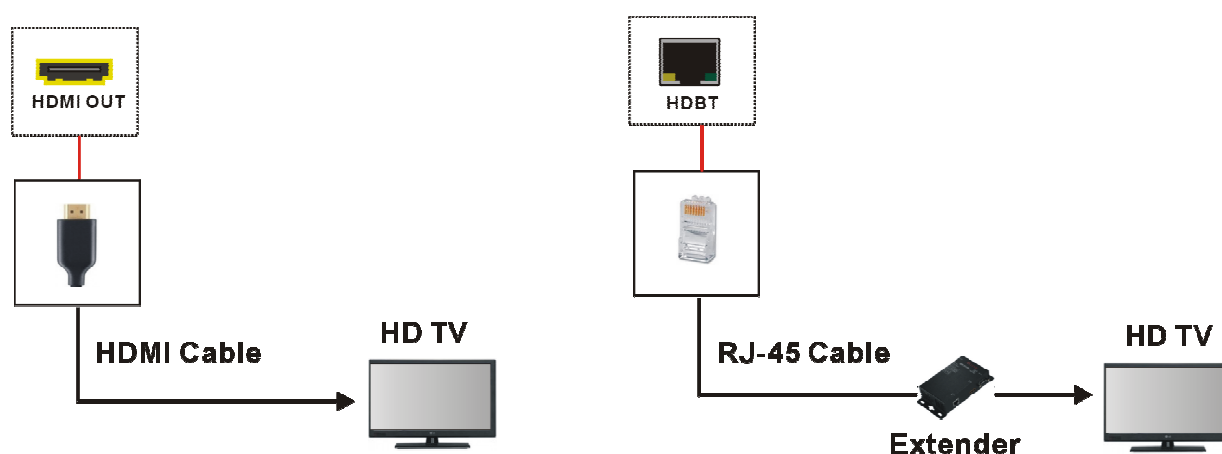

Figure 5-4 Output Connections

## 5.3 Multiple Connections

- **MIC:** Connected to the microphone.
- **SPDIF:** Uses the SPDIF cable with RCA or Toslink connector to connect the SPDIF port on the rear panel to the AVR device. Then, transmit signals through coaxial or fibre optic of SPDIF cable.
- **Audio R/L:** Uses the Audio R/L cable to connect the R/L port to DVD Player for audio connection.
- **YPbPr:** Uses the YPbPr cable to connect the YPbPr port to DVD Player for video connection.
- Use the RS232 cable with 3.5mm connector to connect the RS232 port on the rear panel to the RS232 jack of PC.
- Use the IR Receiver and IR Blaster to connect the IR ports (RX/TX) on the real panel for remote control.

☞ The Switcher integrates the IR RX/TX and RS232 input signals and outputs the signals via the RJ-45 port simultaneously. Through the extender, the output signals will be transmitted to the remote device.

## 5.4 Remote Control Connection

Use the RS232 connecting cable to connect the computer serial communication port (COM1 or COM2) to the RS232 communication port of the Switcher. The computer can then be used to control the Switcher after installing of application software. Aside from using the front panel keys for switching operation, you are also permitted to use the RS232 connection port for a remote operation.

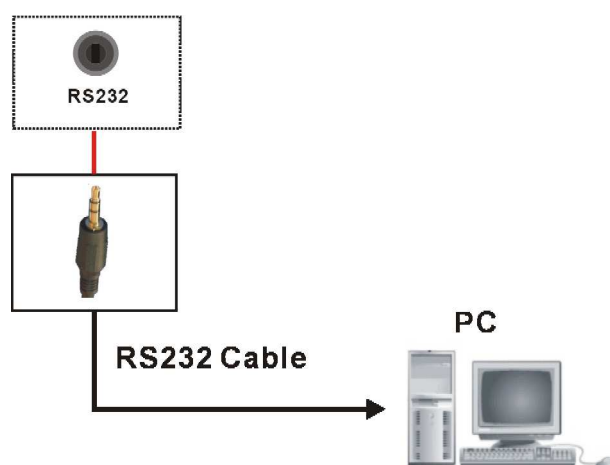

Figure 5-5 RS232 and Control PC connection

## 5.5 IR Pass-Through Connection

The Switcher provides an IR Receiver cable and IR Blaster cable accessories for IR pass-through; on the other hand, it also provides you an extended IR pass-through transmission through Extender.

- Supports you an IR channel to control the TV-end of your Switcher and Remote.
- Supports all kinds of IR frequency band

You can extend the signal connection through the Extender described as below.

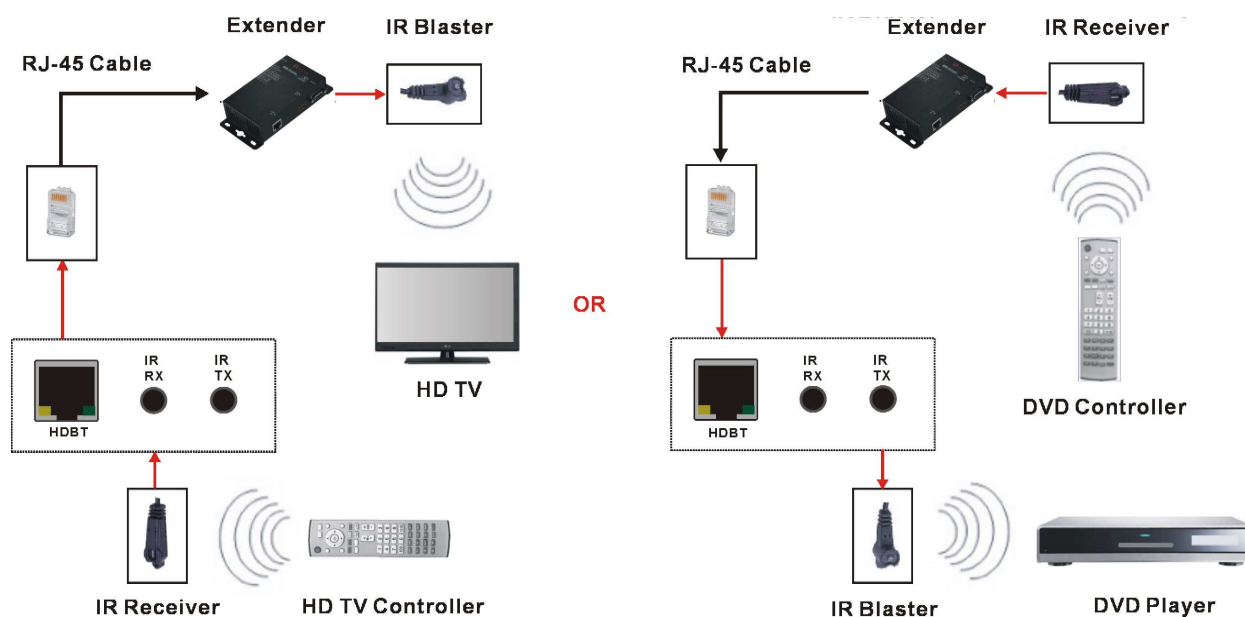

Figure 5-6 IR Extended Connection

## 5.6 Power Connection

Use the included power cord to connect from the power port on the rear panel of the Switcher to the outlet.

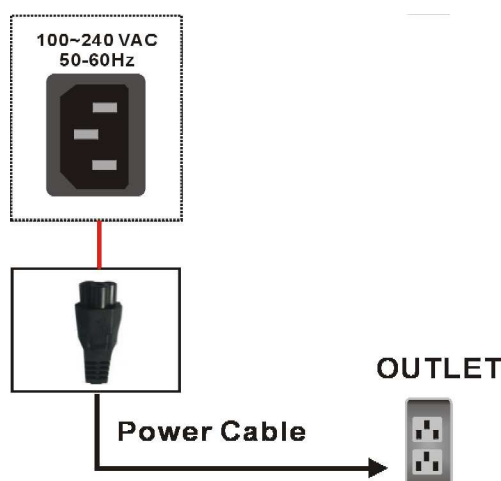

Figure 5-7 Power Connection

## 5.7 I/O Ports

### 5.7.1 RS232

The RS232 Pin functions are described as below:

Pin No.	Abbreviation	Description
1	N/u	Null
2	TXD	Send
3	RXD	Receive
4	N/u	Null
5	GND	Ground
6	N/u	Null
7	N/u	Null
8	N/u	Null
9	N/u	Null

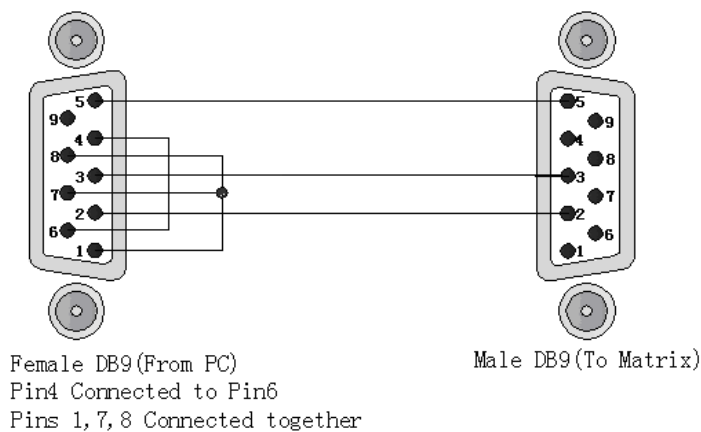

**Figure 5-8a RS232 Pin Function**

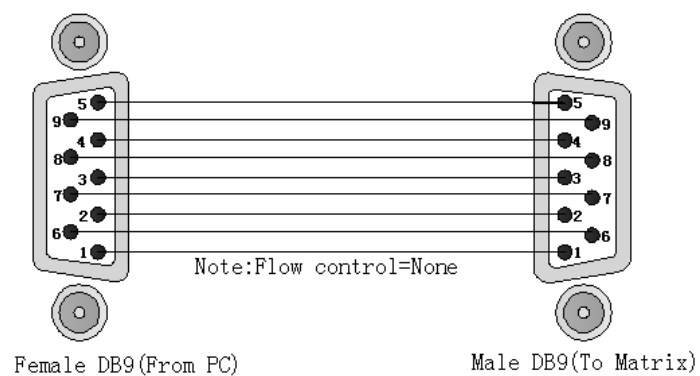

**Figure 5-8b RS232 Pin Function**

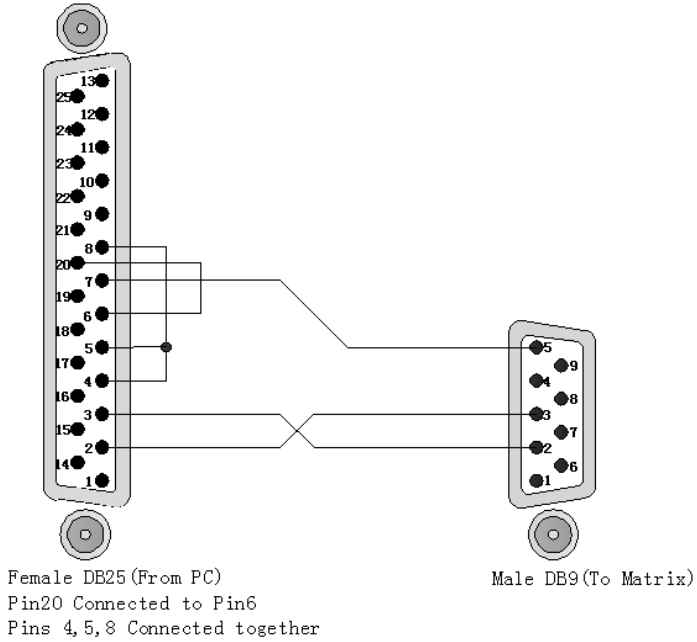

Figure 5-8c RS232 Pin Function

The Switcher RS232 port is defined by DCE.

5.7.2 HDBT

The Switcher supports HDBaseT output for a long distance signal transmission. Output connector is RJ-45 jack with two LED indicators using the 8P8C modular connector, which specifies the physical male and female connectors as well as the pin assignments of the wires in a LAN cable. (A common LAN cable is available.) And the LED indicators show you the status of output transmission.

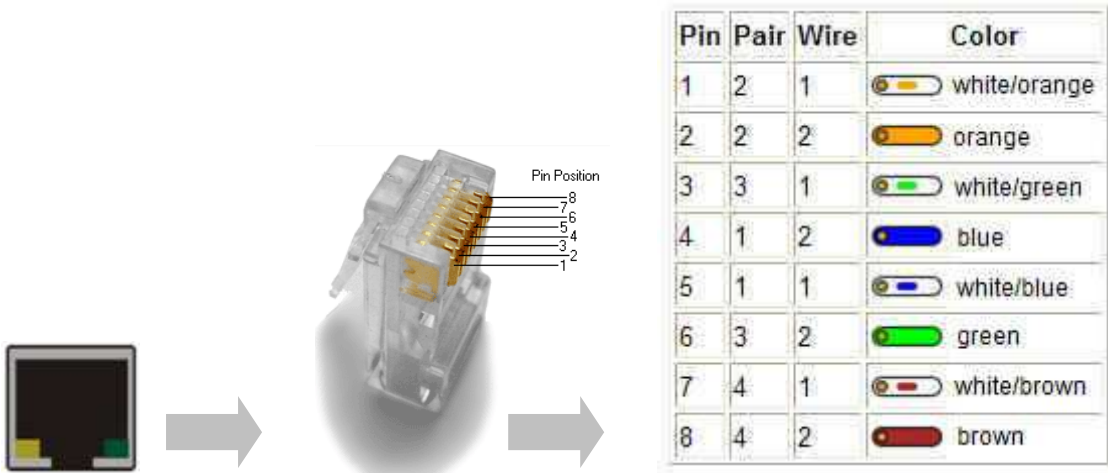

Figure 5-9 LAN (HDBT) Port



- \* The left of RJ-45 output jack is specified for HDCP LED (Yellow).
- \* The right of RJ-45 output jack is specified for LINK LED (Green).

☞ The LED indicators are only designed for the Output – RJ-45 jack of the Switcher.

**LED Indicators:**

LED	Off	Blink	On
<b>LINK (Green)</b>	No Link	Low Power Mode	HDBaseT Link
<b>HDCP (Yellow)</b>	No HDMI Signals	No Encryption	HDCP Encryption

**5.7.3 Output Cable**

HDBaseT was designed to provide Full HD performance up to 100/70 meters of Cat.5e or superior cables. In a typical installation, the cable is stretched to its full length between the HDBaseT Transmitter device and the HDBaseT Receiver device. However sometimes, especially, in demonstrations or in a lab environment, the cable is rolled randomly in small turns for convenience. The randomly rolled UTP cable suffers additional signal impairments (compared to straight cable) and therefore the maximal operating reach might be reduced. When a Cat.5e cable is randomly rolled, it is recommended to limit its length to approximate 50 meters. Rolling a Cat.5e cable around a 70cm fixed diameter plastic drum has just a minor effect on the FEXT (Far End Cross Talk) when compared to a fully stretched cable.

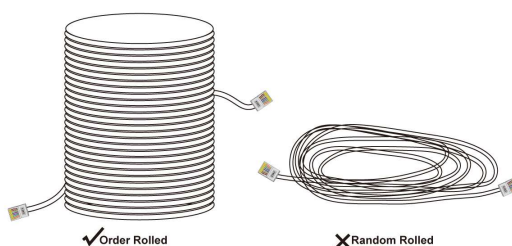

**Figure 5-10 Output LAN Cable**

**The VS010 family features the following:**

When the VS010 is in low power mode (LPPF1/2), the sample rate of the PDIF channel is reduced to 100 KHz. This implies that high data rates may not be used when the VS010 is in LPPF.

Enables 10.2 Gbps of HDMI 1.4 traffic (including HDCP) over a single LAN cable according to the following specifications:

Cable Type	Range	Supported Video
<b>CAT5e/CAT6</b>	60 meters	Most common full HD formats: - Up to 1080P, 60Hz, 36bpp - Data rates lower than 5.3 Gbps or below 225 MHz TMDS clock
<b>CAT6a/CAT7</b>	70 meters	
<b>CAT5e/CAT6</b>	35 meters	Ultra HD video formats: - Deep color: 1080P, 60Hz, 48bpp - 4K x 2K - Data rates higher than 5.3 Gbps or above 225MHz TMDS clock
<b>CAT6a/CAT7</b>	40 meters	

Full HD support: 1080P@60Hz@48b/pixels, 3D, 4K x 2K

## CHAPTER 6 TROUBLESHOOTING

---

1. What to do if LCD is fail in display?

**Answer:** Check the connection of power cord is not loosening and the power cord is in a good status having no any damage. Check the power source is normally.

2. What to do if the Switcher front panel keys switching not responsive?

**Answer:** The Switcher front panel keys employ scanning testing and require longer response time. Press the keys for 2 seconds and then release. This way, key switching will be responsive in operation.

3. What to do if the serial port (usually refer to the computer serial port) fails to control the Switcher?

**Answer:** Check that the communication port set by the control software is correctly connected to the corresponding serial port of the equipment. Also, check if the computer communication port is in good order. If the Switcher supports DIP configuration, please check the ID address and DIP Switcher is configured correctly.

4. What to do if the corresponding audio signal fails to output during Switcher switching?

**Answer:**

(1) Check if there is signal on the input end. If there is no input signal, it could be that the input connection cable is broken or the connector gets loosen. You are advised to replace the connection cable.

(2) Check if there is signal on the output end. If there is no output signal, it could be that the cable is broken or the connector gets loosen. You are advised to replace the connection cable.

(3) Check if the output port number is the same as the controlled port number.

(4) Check the connections of input and output ports are correctly.

(5) If none of the above circumstances happen, it could be internal failure of the product itself. You must send for repair by qualified technical engineers.



5. What to do if you sense the power leakage during plugging or unplugging of the input/output ports?

**Answer:** It could be that the equipment power is not properly grounded. You must properly ground your equipment; otherwise product life can easily be shortened.

6. What to do if the Switcher panel keys and communication ports are out of order?

**Answer:** Check if the equipment power input is in good contact and the computer communication ports are in good order. If yes, it could be some internal failure of the product, please send for repair by qualified technical engineer.

7. What to do if operation and function failure occurred?

**Answer:** Check if the equipment and the Switcher system are in proper connection. If the problem persists, send the product to the maintenance center for repair.

8. How to avoid the equipment failure due to the high temperature?

**Answer:** Place the equipment in a ventilate location. If it is still not to be improved, please check with the build-in fan whether is damaged. Or contact your agency for helping.

9. What to do if IR function failure occurred?

**Answer:** Check the battery of remote controller is NOT running low and the IR connector is not loosening. Check whether the remote controller is aiming at the IR receiver accurately.

## APPENDIX A HDBASET FIRMWARE UPGRADE

Process the Update TX\_xxx.bat or UpdateRX\_xxx.bat file to upgrade firmware. (xxx is specified for firmware version) These files are used for upgrading the VS010TX/VS010RX IC in your devices.

- The UpdateTX\_xxx.bat file is used to upgrade the Switcher or D.A system (the VS010TX IC in your Switcher) firmware.
- The UpdateRX\_xxx.bat file is used to upgrade the Extender (the VS010RX IC in your HX-SRUW) firmware.

### A-1 HX-SRUW HDBaseT F/W Upgrade

Follow the steps as below to upgrade the Extender firmware:

1. Connect the control PC and HX-SRUW with a RS232 cable.

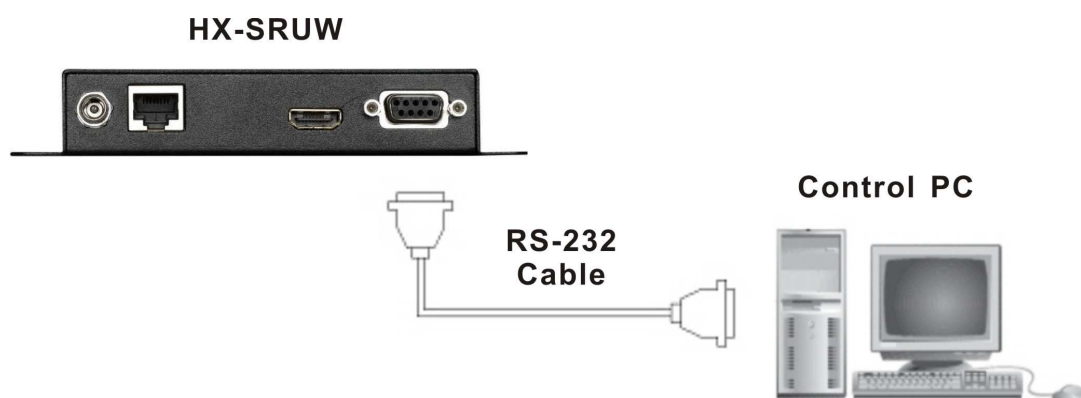

Figure A-1 HX-SRUW F/W Upgrade 1

2. Connect the DC 12V adapter
3. Adjust the F/W DIP switch on the Extender.

#### Remote (Receiver) Firmware Upgrade:

	Pin 1	Pin 2
REMOTE	ON	OFF

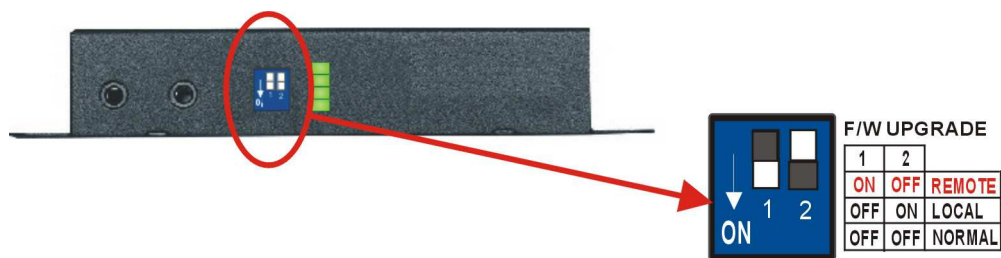

Figure A-2 HX-SRUW F/W Upgrade 2

4. On the control PC, process the UpdateRX\_23090-C.bat file to upgrade firmware. (The update file name is only for reference, it will be different based on version.)

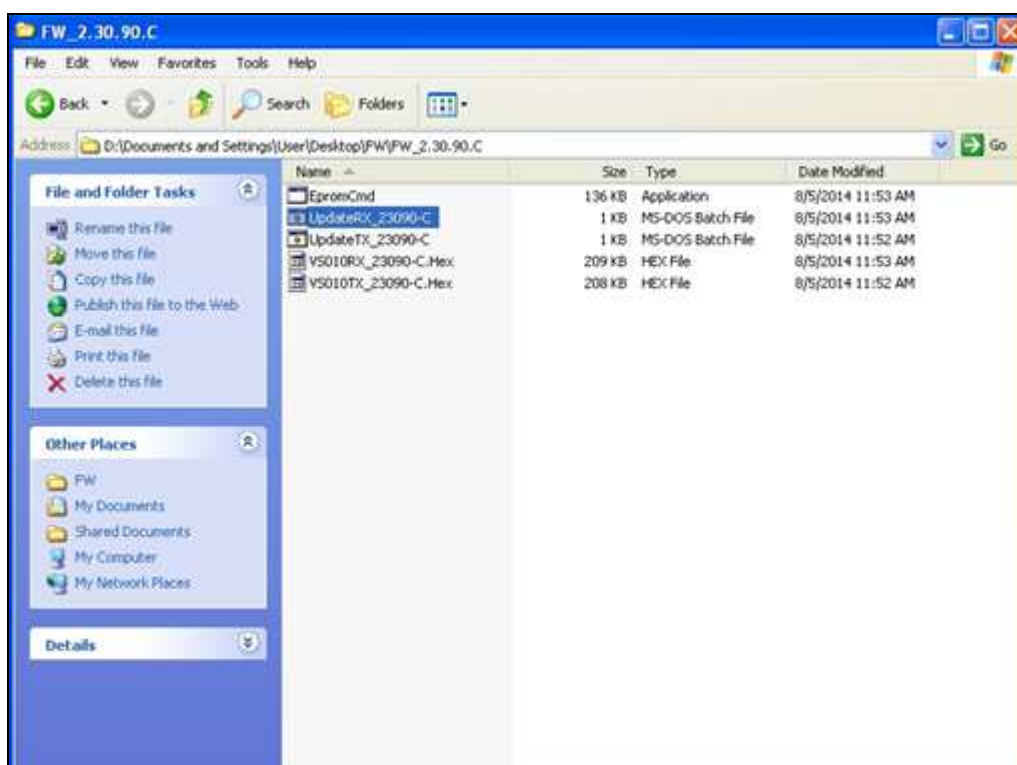

Figure A-3 HX-SRUW F/W Upgrade 3

5. Final, the update is finished as below.

```
D:\WINDOWS\system32\cmd.exe
D:\Documents and Settings\User\Desktop\FW\FW_2.30.90.C>EpronCad ua BU US010RX_23090-C.Hex
Ver 1.0.0.28
Found sink on port 5
Autodetect platform: full
Detected SPI serial flash.
Autodetect size: 128k
Hex mode
Burning file US010RX_23090-C.Hex, total lines: 2773
Erasing serial flash....Done.
progress: 100%
Total bytes: 88672. Total time: 149.360000 seconds
Burn succeeded.

Hex mode
Verifying file US010RX_23090-C.Hex, total lines: 2773
progress: 100%
Total bytes: 88672. Total time: 132.953000 seconds
Verification succeeded!!! :->

D:\Documents and Settings\User\Desktop\FW\FW_2.30.90.C>pause
Press any key to continue . . .
```

Figure A-4 HX-SRUW FW Upgrade 4

## A-2 Switcher HDBaseT F/W Upgrade

Follow the steps as below to upgrade the Switcher firmware:

1. Connect the control PC and HX-SRUW with a RS232 cable.

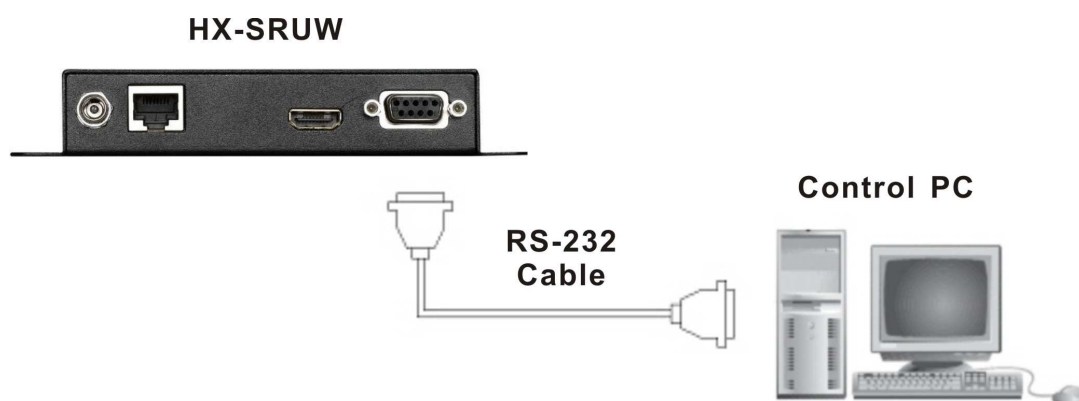

Figure A-5 Switcher HDBase T F/W Upgrade 1

2. Connect the TV and HX-SRUW with a HDMI cable.

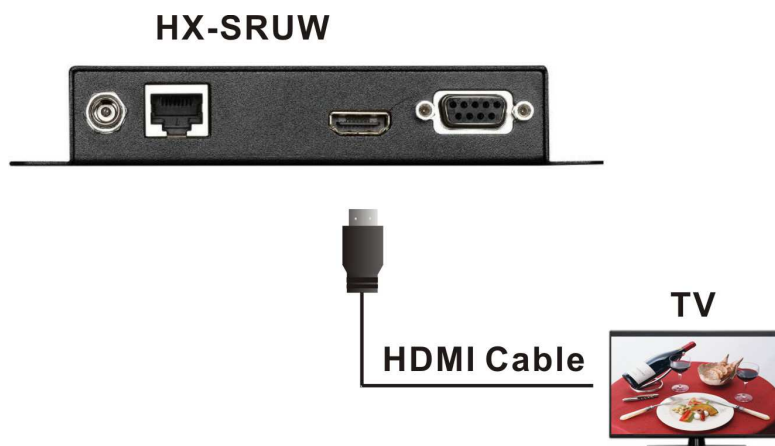

Figure A-6 Switcher HDBase T F/W Upgrade 2

3. Connect the DVD Player and Switcher with a HDMI cable.



Figure A-7 Switcher HDBase T F/W Upgrade 3

4. Connect the LAN cable to the LINK IN port on the side panel of Extender. The other end of the LAN cable connected to the HDBT port of Switcher.

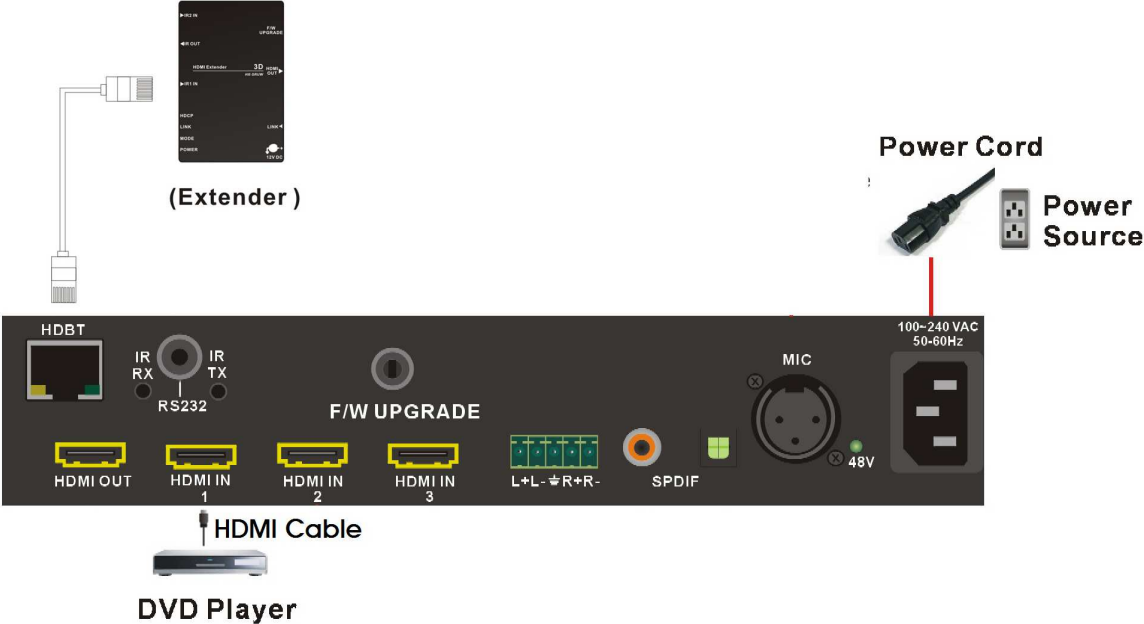

Figure A-8 Switcher HDBase T F/W Upgrade 4

5. Connect the DC 12V adapter.
6. Enable the Switcher, TV and DVD player power, and play the video comes from the DVD Player.
7. Adjust the HX-SRUW F/W Upgrade switcher to LOCAL mode.

Local (Switcher) Firmware Upgrade

	Pin 1	Pin 2
<b>LOCAL</b>	OFF	ON

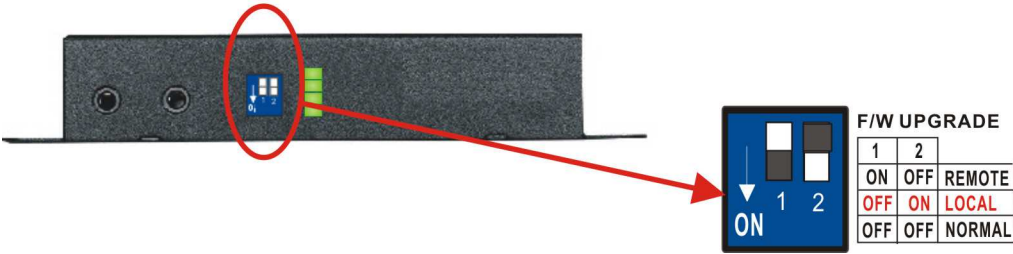

Figure A-9 Switcher HDBase T F/W Upgrade 5

8. On the control PC, process the UpdateTX\_23090-C.bat file to upgrade firmware.  
(The update file name is only for reference, it will be different based on version.)

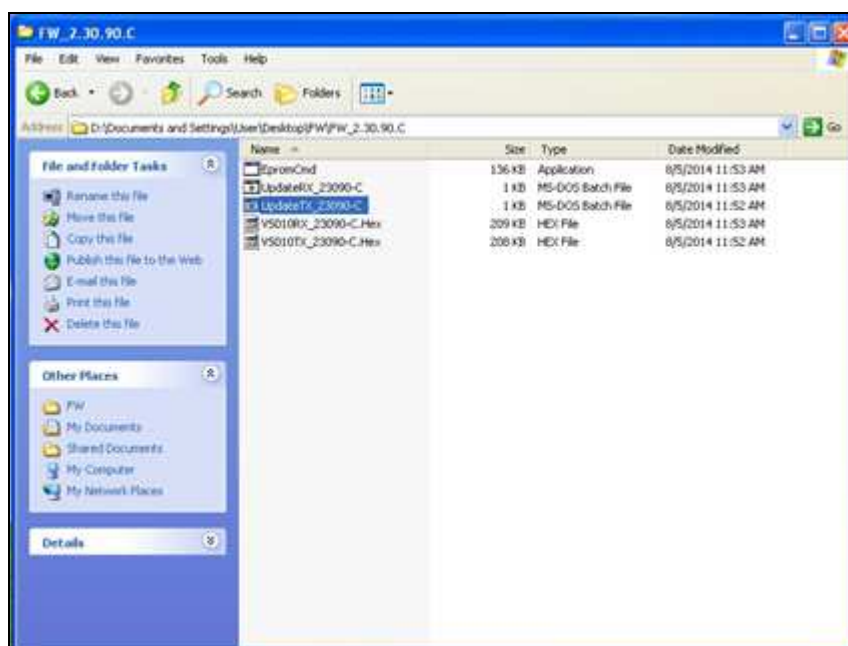

Figure A-10 Switcher HDBase T FW Upgrade 6

9. Final, the update is finish as below.

```

D:\WINDOWS\system32\cmd.exe
D:\Documents and Settings\User\Desktop\FW\FW_2.30.90.C>EpronCnd ua BU US010TX_23090-C.Hex
Ver 1.0.0.28
Found source on port 5
Autodetect platform: Source
Detected SPI serial flash.
Autodetect size: 128k
Hex mode
Burning file US010TX_23090-C.Hex, total lines: 2755
Erasing serial flash...Done.
progress: 100%
Total bytes: 88096. Total time: 148.844000 seconds
Burn succeeded.

Hex mode
Verifying file US010TX_23090-C.Hex, total lines: 2755
progress: 100%
Total bytes: 88096. Total time: 132.203000 seconds
Verification succeeded!!! :->

D:\Documents and Settings\User\Desktop\FW\FW_2.30.90.C>pause
Press any key to continue . . .

```

Figure A-11 Switcher HDBase T FW Upgrade 7

10. Each procedure only updates one port; please follow the same procedures to update other OUT ports.

Implementation of the Switcher HDBaseT F/W Upgrade should be at the active status (the video playing on TV is normal display). Otherwise, it will enter power-saving mode.

# APPENDIX B EXTENDER

The extension of HDMI video signal device supports up to 70 meters away by using an Extender and Cat.5e cable.

### HDMI Extender is ideal for:

- Test bench facilities
- Data Center
- Help desks

### HX-SRUW Extender

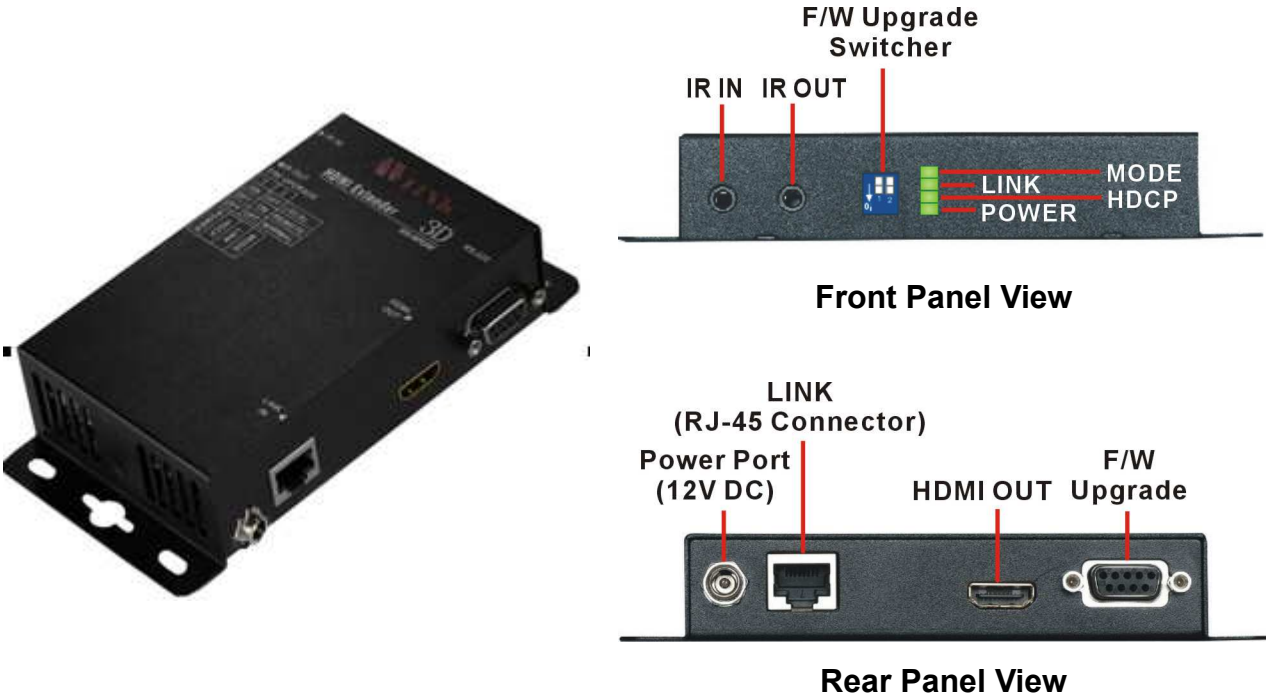

Figure B-1 HX-SRUW Extender



**LED Indicators (Green):**

LED	Off	Blink	On
<b>MODE</b>	-	Power Connected	-
<b>LINK</b>	No Link	Low Power Mode	HDBaseT Link
<b>HDCP</b>	No HDMI Signals	No Encryption	HDCP Encryption
<b>POWER</b>	Power Off	-	Power On

**HX-SRUW Extender: F/W Upgrade Switcher (2-Pin)**

	Pin 1	Pin 2	Description
<b>REMOTE</b>	ON	OFF	Through the RS232 connection to upgrade Receiver unit.
<b>LOCAL</b>	OFF	ON	Through the LAN Connection to upgrade Transmitter (PS-301/PS-301M).
<b>NORMAL</b>	OFF	OFF	Extend the RS232 Signal Transmission

**B-1 Features**

- Through the Extender, you can use the output of the Switcher to display identical image and extension of HDMI signal up to 70 meters on HDTV
- HDCP Compliant
- Supports F/W Upgrade (Optional)
- Supports 3D pass-through
- Supports all frequency band IR pass-through
- Supports IR/RS232 extension function.
- One Cat.5e cable extension
- Supports resolution up to 4K x 2K
- HDBaseT technology
- Use Cat.5e cable to install easily

## B-2 Specifications

Hardware	
HDMI OUT	HDMI A-Type Female x 1
LINK	RJ-45 Connector x 1
IR OUT	3.5 $\psi$ Stereo Jack x 1
IR IN	3.5 $\psi$ Stereo Jack x 1
2 Pins Dip Switch	F/W Upgrade Setting
RS232 Connector	DB9 Female x 1 (For F/W Upgrade)
LED indicators	MODE/LINK/HDCP/POWER
Power Supply	DC 12V with Lock
Housing	Metal
Weight	308g
Dimensions (LxWxH)	150x80x35mm
Multimedia	
Max. Resolution	4K x 2K@30Hz, 8-bit
Highest TMDS Frequency	300MHz
Control Information	
HDMI Cable Distance	10 meters (At least)
Cat.5e Cable Distance	70 meters (Max.)
Remote Control	IR Receiver, IR Blaster

## B-3 IR Receiver Cable Directions

Put IR Receiver cable into the Receiver “IR IN” port and place the IR Receiver Cable, so that you can aim at it easily with your IR remote controller.

### IR Receiver Cable:



Figure B-2 IR Receiver Cable

## B-4 IR Blaster Cable Directions

Plug IR Blaster cable into Receiver “IR OUT” port located on the front-panel.

### IR Blaster Cable:



Figure B-3 IR Blaster Cable

## B-5 HDMI Output Connector

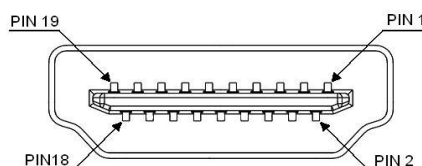

Figure B-4 HDMI Output Connector

### HDMI Type A Connector Host Assignment:

Pin #	Signal	Pin #	Signal
1	TMDS Data 2+	11	TMDS Clock Shield
2	TMDS Data 2 Shield	12	TMDS Clock -
3	TMDS Data 2-	13	NC
4	TMDS Data 1+	14	NC
5	TMDS Data 1 Shield	15	DDC SCL
6	TMDS Data 1-	16	DDC SDA
7	TMDS Data 0+	17	DDC/CEC Ground
8	TMDS Data 0 Shield	18	+5V Power
9	TMDS Data 0-	19	Hot Plug Detect
10	TMDS Clock+		

## B-6 Wiring Information for Link Connector

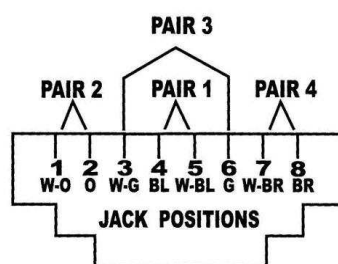

Figure B-5 RJ-45 Pin Assignment

### RJ-45 Pin Assignment:

Conductor Identification	RJ-45 Pin Assignment	Color Code for Conductor
Pair 1	5	White-Blue
	4	Blue
Pair 2	1	White-Orange
	2	Orange
Pair 3	3	White-Green
	6	Green
Pair 4	7	White-Brown
	8	Brown

## APPENDIX C EXTEND AUDIO AMPLIFIER

The Switcher allows you to connect an audio amplifier for the extended speaker. Electrical power transferred from an audio amplifier to a loudspeaker, the speaker power handling is reached to 25W.

### Extend Audio Amplifier

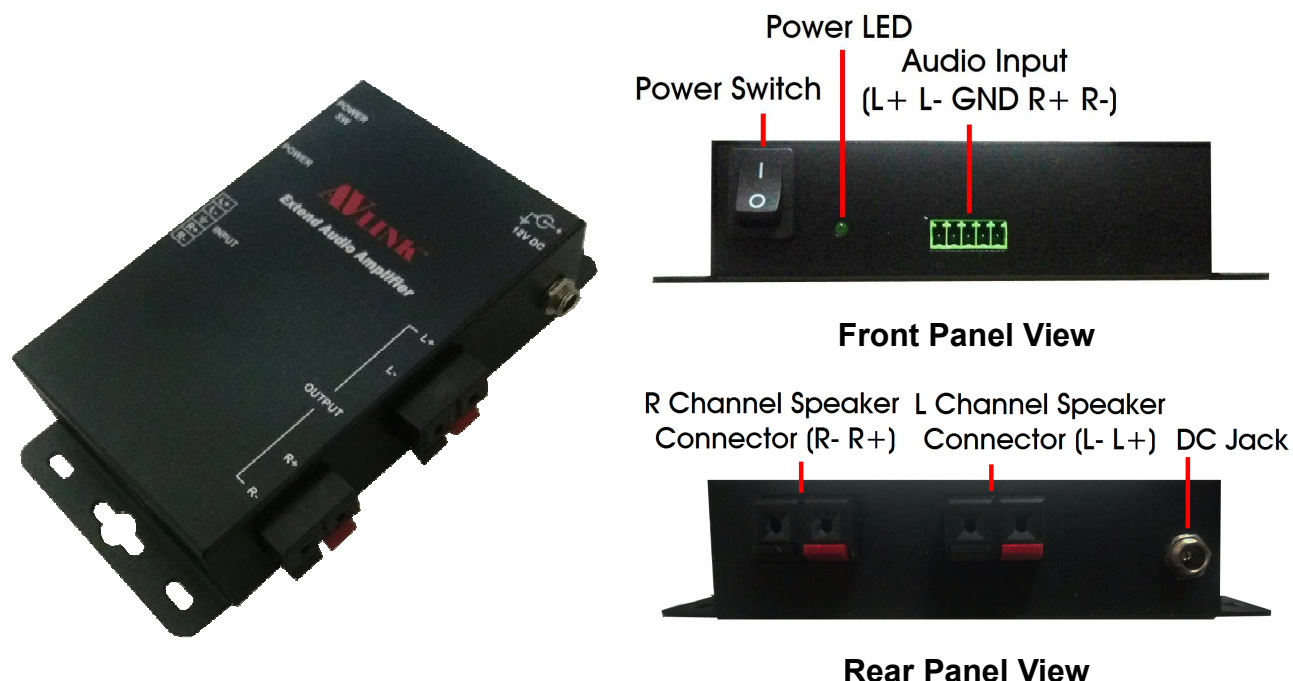

Figure C-1 Extend Audio Amplifier

#### LED Indicators (Green):

LED	Off	Blink	On
POWER	Power Off	-	Power On

### C-1 Specifications

Hardware	
Audio Input	Terminals Block (Differential) x 1
Audio Output	Speaker Connector x 2
Power	DC12V 5A with Lock x 1
Housing	Metal

# C-2 Audio Amplifier Connection

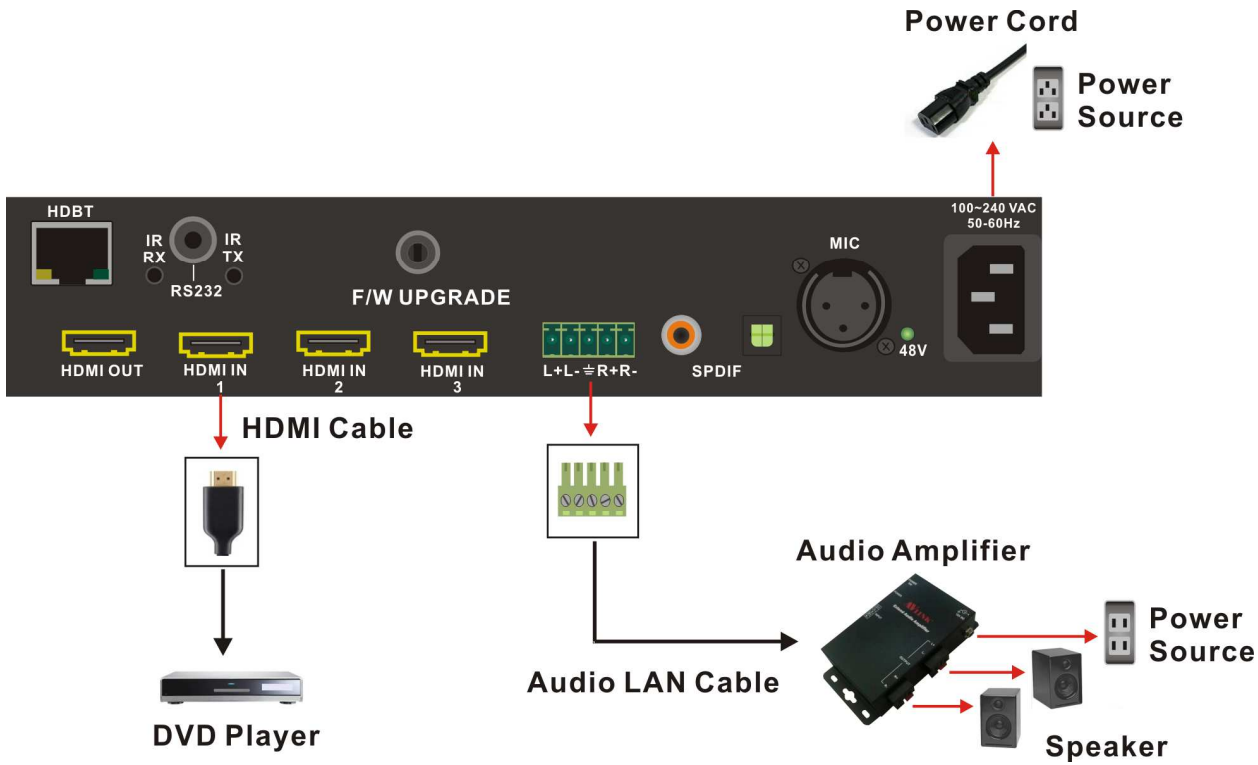

Figure C-2 Audio Amplifier Connection