

AVMATRIX



SHARK S6

**6 CHANNEL HDMI/SDI MULTI-FORMAT
STREAMING VIDEO SWITCHER**

USING THE UNIT SAFELY

Before using this unit, please read below warning and precautions which provide important information concerning the proper operation of the unit. Besides, to assure that you have gained a good grasp of every feature of your new unit, read below manual. This manual should be saved and kept on hand for further convenient reference.



Warning And Cautions

- ※ Operate unit only on the specified supply voltage.
- ※ Disconnect power cord by connector only. Do not pull on cable portion.
- ※ Do not place or drop heavy or sharp-edged objects on power cord. A damaged cord can cause fire or electrical shock hazards. Regularly check power cord for excessive wear or damage to avoid possible fire / electrical hazards.
- ※ Ensure unit is properly grounded at all times to prevent electrical shock hazard.
- ※ Do not operate unit in hazardous or potentially explosive atmospheres. Doing so could result in fire, explosion, or other dangerous results.
- ※ Handle with care to avoid shocks in transit. Shocks may cause malfunction. When you need to transport the unit, use the original packing materials or alternate adequate packing.
- ※ Do not remove covers, panels, casing, or access circuitry with power applied to the unit! Turn power off and disconnect power cord prior to removal. Internal servicing / adjustment of unit should only be performed by qualified personnel.
- ※ Turn off the unit if an abnormality or malfunction occurs. Disconnect everything before moving the unit.

Please select the best installation position

- ※ Do not cover the air inlet and outlet of the unit, make sure that there is sufficient space around the ventilation holes on both sides to avoid blockage of ventilation.
- ※ To avoid falling or damage, please do not place this unit on an unstable cart, stand, or table. Make sure install this unit on a very stable horizontal surface for use.
- ※ Do not use this unit in a humid, dusty location or near water. Avoid liquids, metal pieces or other foreign materials to enter the unit.
- ※ Do not use this unit in an environment where the temperature is too cold or too hot.
- ※ Avoid placing this unit in direct sunlight or in a place where hot air from other products can blow.

Note: due to constant effort to improve products and product features, specifications may change without notice.

CONTENTS

1. BRIEF INTRODUCTION	1
1.1. Overview	1
1.2. Main Features	1
2. INTERFACES	2
2.1. Interface Overview	2
2.2. Tally PIN Definition	2
2.3. RS232/RS422/RS485 (DB9) Definition	3
3. SPECIFICATION	3
4. FRONT CONTROL PANEL	5
5. LCD SCREEN	6
5.1. Multiview Monitoring	6
5.2. Menu Interface	6
6. SIGNAL SWITCHING	7
6.1. PGM & PVW Channel Selection	7
6.2. Transition: CUT/ AUTO/ T-BAR	8
7. TRANSITION EFFECT	8
7.1. WIPE	8
7.2. DIP	8
7.3. MIX	9
7.4. Transition Speed	9
8. UPSTREAM KEY	9
8.1. Chroma key	9
8.2. PIP & POP	11
9. DOWNSTREAM KEY	12
9.1. TIE	13
9.2. DSK	13
9.3. LOGO	14
10. MULTIVIEW	15
10.1. Multiview Layouts	15

10.2. Audio Meter	16
10.3. Input Information	16
10.4. UMD Settings	17
11. OUTPUT SETTINGS	17
11.1. Output Interfaces	17
11.2. Output Format Settings	18
11.3. FTB	20
11.4. STILL	20
12. AUDIO SETTINGS	20
12.1. Master Audio	21
12.2. Audio Volume	21
12.3. Audio On (MIX)	21
12.4. AFV (Audio-Follow-Video)	21
12.5. Audio Delay	21
12.6. MIC	22
12.7. Earphone	22
13. STREAM & RECORD	22
13.1. Streaming	22
13.2. Recording	26
14. PTZ CONTROL	27
15. SYSTEM SETTINGS	28
15.1. Language	28
15.2. Fan Settings	29
15.3. ROC Correction	29
15.4. System Reset	29
15.5. Version	29
15.6. Time Settings	29
15.7. Network Settings	30
15.8. Customize Shortcut Keys	30
15.9. User Settings	31
16. WEB CONTROL INTERFACE	31

1. BRIEF INTRODUCTION

1.1. Overview

SHARK S6 is a 6-channel HDMI&SDI multi-format video Switcher with a 5-inch LCD display. It supports various functions including LAN streaming, recording, video switching, audio mixing, PGM/ Multiview/ AUX out, different transition effects, Luma Key, Chroma Key, DSK, LOGO, PIP/ POP, PTZ control etc.



1.2. Main Features

- Built-in 5-inch LCD display
- Input: 4×SDI and 2×HDMI
- Output: 2×SDI, 1×HDMI PGM, 2×SDI AUX ,1×HDMI Multiview, 1×USB Type-C,
- Professional chroma Key, downstream key, 2PIP/ POP, and LOGO overlay
- T-bar/ Auto/ Cut transitions, various effects: MIX/ DIP/ WIPE effects
- FTB/ STILL, GPIO port for tally system, RS232/RS422/RS485
- Multiview layout style: Landscape and portrait mode
- RTMP stream & USB disk/ SD card record
- USB-C for capturing and streaming on PC
- Audio mixer: 4×SDI, 2×HDMI audio & 2×MIC in
- PTZ camera control: VISCA, VISCA over IP, PELCO & ONVIF protocols

2. INTERFACES

2.1. Interface Overview

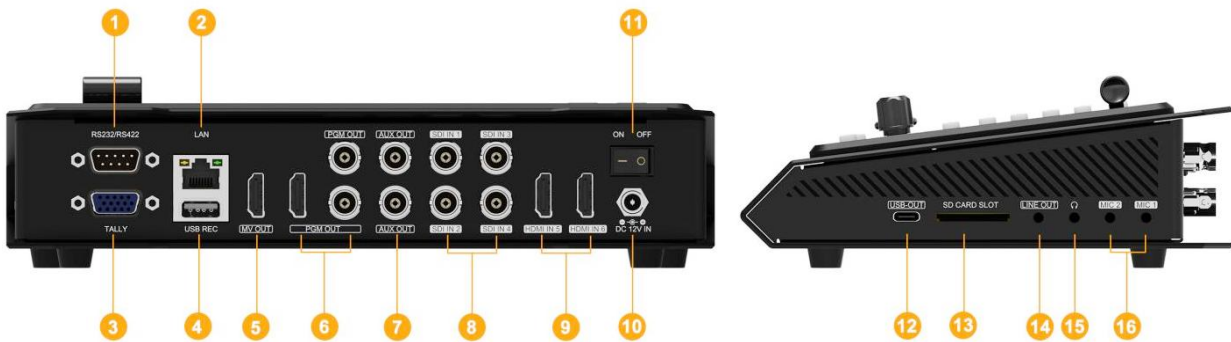

1	RS232/RS422/RS485	9	HDMI IN × 2
2	LAN (for streaming and PC remote control)	10	DC 12V IN × 1
3	GPIO (for tally)	11	POWER SWITCH
4	USB REC (for recording and importing logo)	12	USB OUT × 1 (for capturing on PC)
5	MULTIVIEW OUT × 1	13	SD CARD SLOT (for recording)
6	HDMI PGM OUT × 1, SDI PGM OUT × 2	14	LINE OUT × 1
7	AUX OUT × 2	15	EARPHONE OUT × 1
8	SDI IN × 4	16	MIC IN × 2

2.2. Tally PIN Definition

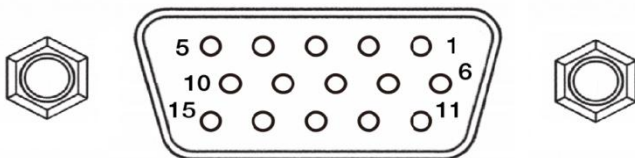

PIN	Definition	PIN	Definition
11	PGM-IN1	6	PVW-IN1
12	PGM-IN2	7	PVW-IN2
13	PGM-IN3	8	PVW-IN3
14	PGM-IN4	9	PVW-IN4
15	PGM-IN5	10	PVW-IN5
3	PGM-IN6	4	PVW-IN6
5	GND	1	GPIO
2	GPIO		

2.3. RS232/RS422/RS485 (DB9) Definition

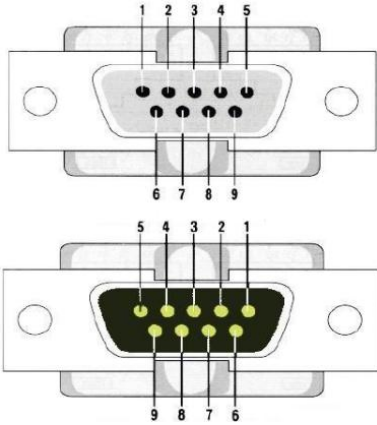

NO.	Port	Definition
1	RXD-	RS422
2	RXD	Receive Data
3	TXD	Transmit Data
4	TXD+	RS422
5	GND	System Ground
6	RXD+	RS422
7	RTS	Request to Send
8	CTS	Clear to Send
9	TXD-	RS422

3. SPECIFICATION

CONNECTION	
Video In	SD/HD/3G-SDI(75Ω) ×4, HDMI type-A(100Ω) ×2
PGM Outputs	HD/3G-SDI(75Ω) ×2, HDMI Type-A(100Ω) ×1
Multiview Outputs	HDMI type-A(100Ω) ×1
AUX Outputs	3G-SDI(75Ω) ×2, including IN1~6, PVW, PGM, Color Bar, Multiview
Stream Output	LAN
Capture Output	USB type-C
Audio Input	MIC ×2
Audio Output	Line ×1, Earphone slot×1
Media Port	USB type-A×1
Camera Control Port	LAN, RS232/RS422/RS485
Tally Port	DB-15
Power In	DC 12V
STREAM& REC	
Bitrate	2M~32Mbps
Rate Control	CBR/VBR
Stream Protocols	RTMP(S)/ RTSP/ SRT
REC SD Card Format	FAT32/exFAT/NTFS
REC USB Disk Format	FAT32/exFAT/NTFS
REC File segment	1~120mins

FUNCTIONS	
Transitions	T-Bar/ AUTO/ CUT
Effects	WIPE(11×3 patterns)/ MIX/ DIP/ STILL(freeze)/ FTB
Multiview Layout	Landscape & Portrait Mode
Upstream Key	Chroma Key ×1, PIP ×2/ POP×1
Downstream Key	DSK ×1, Logo ×1
Audio Function	AFV, Mix, Audio delay
Logo Library	Up to 8 PNG images
Record Storage	USB Disk/ SD Card
Display	5-inch HD LCD Display
STANDARDS	
SDI Input Format Support	1080p 60/59.94/50/30/29.97/25/24/23.98 1080psF 30/29.97/25/24/23.98 1080i 60/59.94/50 720p 60/59.94/50/30/29.97/25/24/23.98 625i 50 PAL, 525i 59.94 NTSC
HDMI Input Format Support	1200p 60/50/30 1080p 60/59.94/50/30/29.97/25/24/23.98/23.976 1080i 50/59.94/60 720p 60/59.94/50/30/29.97/25/24/23.98 576i 50, 576p 50
PGM Output Format	1080p 60/59.94/50/30/29.97/25/24/23.98 1080i 60/50/59.94
Multiview Output Format	1080p 60
Color Space	RGB Full/ RGB Limited/ YUV
SDI Video Rate	Auto Detection, SD/HD/3G-SDI
SDI Compliance	SMPTE 292M/ SMPTE 259M/ SMPTE 424M
USB Capture Out	MJPEG, up to 1080p 60
Supports OS	Windows 7/8/10/11, Linux (Kernel version 2.6.38 and above), Mac OS (10.8 and above)
Capture Compatibility	OBS Studio, Skype, ZOOM, Teams, Youtube, Live, etc.
OTHERS	
Power	DC 12V 1.5A, 18W
Dimension (LWD)	238.5×168.2×47.5mm
Weight	Net Weight: 1450g, Gross Weight: 2370g

Temperature	Working: -20°C~60°C, Storage: -30°C~70°C
-------------	--

4. FRONT CONTROL PANEL



1	FTB/STILL	FTB: Fade to Black, used for emergency. STILL: Freeze the input sources.
2	EFFECT & AUDIO & KEYS	EFFECT: WIPE/MIX/DIP AUDIO: User can configure the audio of each channel in this area, including AFV or audio mix mode, audio source selecting, adjust volume + & volume - CHROMA: Enable the Chroma Key PIP1/PIP2: Enable two group of Picture in Picture. Size and position can be set via Menu. DSK: Enable the downstream key LOGO: Add logo bin from USB flash disk, enable the logo overlay
3	STREAM & RECORD	STREAM: For streaming RECORD: Record the image on a USB disk or SD card
4	PTZ Control	Use the joystick and buttons to pan, tilt and zoom the PTZ camera.
5	PGM & PVW	Selecting the signal source for Program and Preview.
6	CUT/ AUTO	CUT: Performs a simple immediate switch between Program and Preview. AUTO: Performs an automated switch between Program and Preview.
7	MENU	For menu control, configure different parameter
8	T-Bar	Switch the PVW and PGM through T-Bar

9	DISPLAY	5-inch LCD display, Multiview monitoring
---	---------	--

5. LCD SCREEN

The switcher is a compact design that build-in a 5 inch LCD screen. Users can conveniently monitor the multiview on the screen or check menu through the screen.

5.1. Multiview Monitoring

The multiview provides clear windows of PVW, PGM, SDI1, SDI2, SDI3, SDI4, HDMI5, HDMI6, and the Record/Stream status page. The multiview's status page provides real-time updates as settings are modified, ensuring users are always aware of the current system configuration. See the below image:

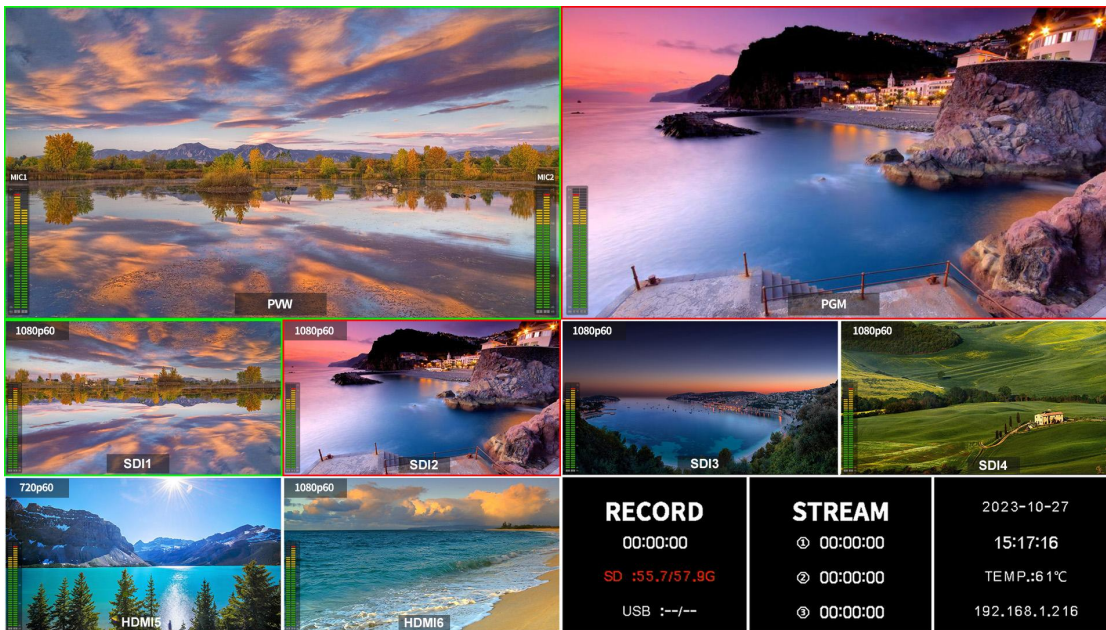

5.2. Menu Interface

Simply press the menu button on the switcher to seamlessly transition from the multiview display to the comprehensive menu interface on the built-in screen. Please mention that the menu is exclusively accessible on the built-in screen and not on the HDMI multiview output.)



6. SIGNAL SWITCHING

6.1. PGM & PVW Channel Selection

Select PGM and PVW sources directly from buttons on the front panel. The selected PGM button will illuminate with a red LED, while the selected PVW button will glow with a green LED. For clear visual identification, PGM source will be framed by a red border, and PVW source will be outlined in green.

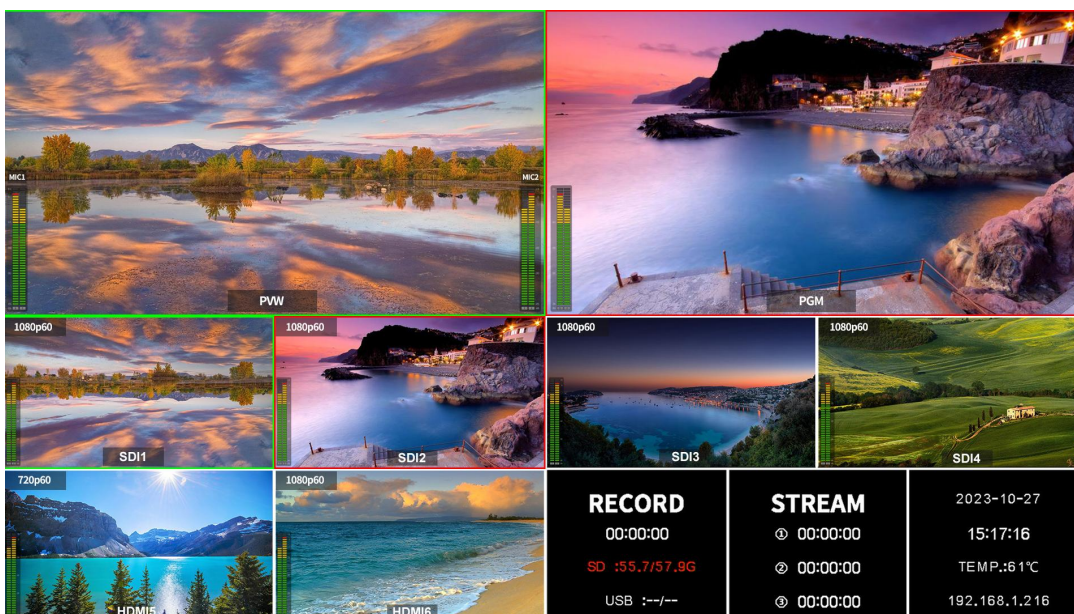

6.2. Transition: CUT/ AUTO/ T-BAR

This video switcher offers three transition control types: CUT, AUTO and T-Bar.

CUT performs a quick transition between Preview and Program, bypassing any selected transition effects like WIPE, MIX, or DIP.

AUTO performs a smooth transition between Preview and Program, allowing to adjust the transition speed using the speed button. WIPE, DIP, and MIX transition effects are available.

T-BAR performs manual transition, which is similar flexible to AUTO transition. Users can control the transition speed by the movement of the T-Bar lever.

7. TRANSITION EFFECT

The video switcher provides various transition effects and settings for choice.

7.1. WIPE

Outside of menu mode, simply press the EFFECT button on the panel to summon a quick menu in the display's left corner. Select the WIPE option to swiftly apply the wipe transition effect. For added customization, adjust the WIPE style and edge softness to your preference. When using the AUTO transition, choose between Normal, Invert, and Flip-Flop directions.

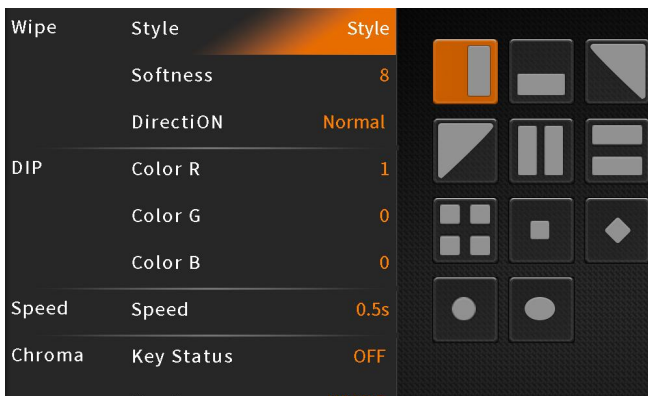

7.2. DIP

Outside of menu mode, simply press the EFFECT button on the panel to summon a quick menu in the display's left corner. Select the DIP option to promptly apply the dip transition effect. For added customization, adjust the DIP color through the DIP RGB menu option. The default color is black.

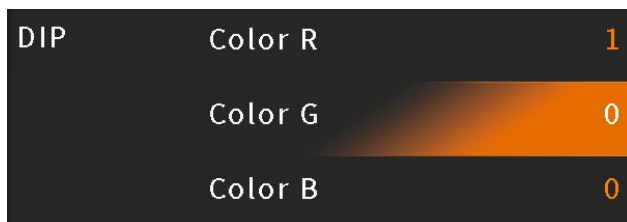

DIP to Black (fade out):



DIP to White (fade out):



7.3. MIX

Outside of menu mode, simply press the EFFECT button on the panel and select the MIX option to swiftly apply the mix transition effect.



7.4. Transition Speed

Customize the transition speed to match your production needs directly from the menu. The selected speed setting will be automatically saved for future use. Higher values correspond to slower transition speeds, with a wide range of options from 0.1 seconds to 8.0 seconds available to cater to diverse creative requirements.

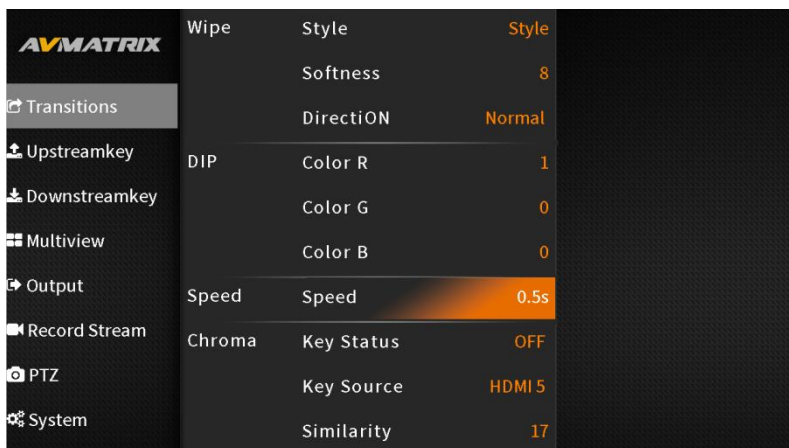

8. UPSTREAM KEY

Upstream keys are intrinsically integrated into the transition process. When switching from Preview to Program, any upstream key elements will seamlessly transition alongside the main video content.

8.1. Chroma key

Chroma key is a visual effects technique that combines (overlay) two images or video streams based on color hues (chroma range). It's commonly used to remove a background from the subject of a photo or

video, particularly in newscasting, movies, and video games.



Access the chroma key menu to select the desired key source from SDI1, SDI2, SDI3, SDI4, HDMI5, HDMI6, Color Bar, or Black video sources. In Fetch XY mode, utilize the 3D joystick to pinpoint the color you want to remove. Fine-tune the chroma key's similarity, smoothness, spill, and opacity to achieve the desired effect. Additionally, configure the chroma key's effect parameters, including Brightness, Contrast, Saturation, and Mask, directly from the menu page.

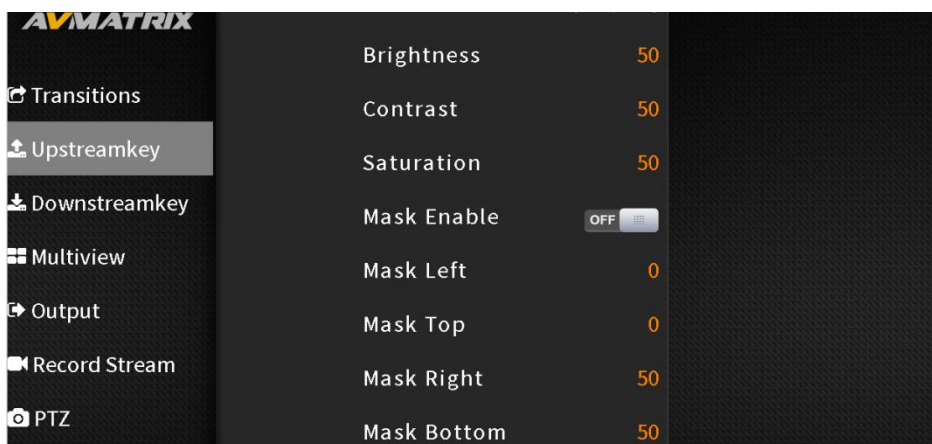
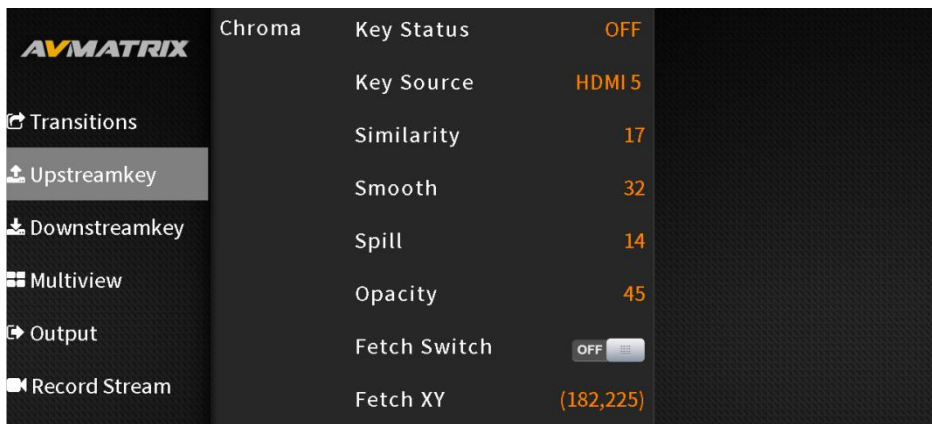

Outside of menu mode, pressing the CHROMA button on the panel prompts a menu for quick selection of chroma key activation on PVW, PGM, or both. Detailed settings can be configured in the menu.

CHROMA button **PGM**: Enables chroma key on PGM

CHROMA button **PVW**: Enables chroma key on PVW

CHROMA button **PGM&PVW**: Enables chroma key on both PVW and PGM

CHROMA button **OFF**: Disables chroma key

Chroma key detailed parameters are as follows:

Menu	Sub-menu	Item	Parameter	Default
Upstream Key	Chroma	Key Status	OFF/ PVW/ PGM/ PVW&PGM	OFF
		Key Source	SDI1/ SDI2/ SDI3/ SDI4/ HDMI5/ HDMI6/ BLACK/ COLOR BAR	COLOR BAR
		Similarity	0~255	5
		Smooth	0~255	5
		Spill	0~255	0
		Opacity	0-128	128
		Fetch Switch	On/Off	On
		Fetch XY	(0,0)	(0,0)
		Brightness	0%-100%	50%
		Contrast	0%-100%	50%
		Saturation	0%-100%	50%
		Mask Enable	On/Off	Off
		Mask Left	0%-100%	0%
		Mask Top	0%-100%	0%
		Mask Right	0%-100%	50%
Mask Bottom	0%-100%	50%		

8.2. PIP & POP



The video switcher supports two PIP or one POP. Outside of menu mode, pressing the PIP1 or PIP2 button on the panel displays a quick menu in the left corner for selecting PIP application on PVW or PGM or both. Access the menu settings, navigate to PIP settings, and configure position, size, border, source,

and other parameters.

PIP1/PIP2 button **PVW**: Displays PIP1 or PIP2 on PVW.

PIP1/PIP2 button **PGM**: Enables PIP1 or PIP2 on PGM.

PIP1/PIP2 button **PVW&PGM**: Enables PIP1 or PIP2 on both PVW and PGM.

PIP1/PIP2 button **OFF**: Disables PIP1 or PIP2.

Configure POP settings in the menu. When POP is active, PIP is disabled.

PIP & POP detailed parameters are as follows.

Menu	Sub-Menu	Item	Parameter	Default
Upstream Key	PIP/POP	Border Status	On/Off	On
		Border Color	Color	White
		Border Width	0~15	2
		PIP1 Status	OFF/ PVW/ PGM/ PVW&PGM	Off
		PIP1 Source	SDI1/ SDI2/ SDI3/ SDI4/ HDMI5/ HDMI6/ BLACK/ COLOR BAR	SDI1
		PIP1 Size	1/2 1/3 1/4	1/3
		PIP1 Position X	0~100	0
		PIP1 Position Y	0~100	0
		PIP2 Status	OFF/ PVW/ PGM/ PVW&PGM	Off
		PIP2 Source	SDI1/ SDI2/ SDI3/ SDI4/ HDMI5/ HDMI6/ BLACK/ COLOR BAR	SDI2
		PIP2 Size	1/2 1/3 1/4	1/3
		PIP2 Position X	0~100	100
		PIP2 Position Y	0~100	0
		POP Status	OFF/ PVW/ PGM/ PVW&PGM	off
		POP Source 1	SDI1/ SDI2/ SDI3/ SDI4/ HDMI5/ HDMI6/ BLACK/ COLOR BAR	HDMI5
		POP Source 2	SDI1/ SDI2/ SDI3/ SDI4/ HDMI5/ HDMI6/ BLACK/ COLOR BAR	SDI2

9. DOWNSTREAM KEY

Downstream keys (DSKs) are the final layers of keying, overlaying all video switched to the main program output. They function independently of the selected background, ensuring that any content placed on a

DSK remains on the screen regardless of transition changes. DSKs are ideal for incorporating animated bugs or logos into the program output.

9.1. TIE

As we know the DSK is usually used for logo or title overlay into the program out directly, but if users want to make downstream key active in transition when use AUTO or T-Bar, can just turn on the TIE option from the menu.

9.2. DSK



DSK settings, including source (Key Source), clip, gain, and mask (Mask Enable, Mask Left, Mask Top, Mask Right, Mask Bottom), can be configured from the menu. Select the PGM button in DSK status to enable the KEY on PGM. The key will not be affected when switching between PVW and PGM. Choose from the following options to determine whether the DSK key applies to PGM or PVW:

Menu	Sub-Menu	Item	Parameter	Default
Downstream Key	DSK	DSK Status	OFF/ PVW/ PGM/ PVW&PGM	Off
		Key Source	SDI1/ SDI2/ SDI3/ SDI4/ HDMI5/ HDMI6/ BLACK/ COLOR BAR	COLOR BAR
		Clip	0%-100%	0%
		Gain	0%-100%	0%
		Invert Key	On/Off	Off
		Mask Enable	On/Off	Off
		Mask Left	0%-100%	0
		Mask Top	0%-100%	0
		Mask Right	0%-100%	0
		Mask Bottom	0%-100%	0

DSK button **PVW**: DSK key shows on PVW

DSK button **PGM**: DSK Key available on PGM

DSK button **PVW&PGM**: DSK Key available on both PVW and PGM

DSK button **OFF**: DSK Key off

Downstream Key detailed parameters are as follows:

9.3. LOGO

The switcher enables users to import logos. Access the logo settings interface by pressing the menu knob and navigate to the media pool on the USB disk to select the desired logo. Rotate the menu knob to adjust logo position, size, and opacity. Press the logo delete button to remove a logo. Up to eight logos can be imported simultaneously. Logo name supports up to 11 characters.

Supported logo formats: PNG

Maximum logo size: 512x320 pixels

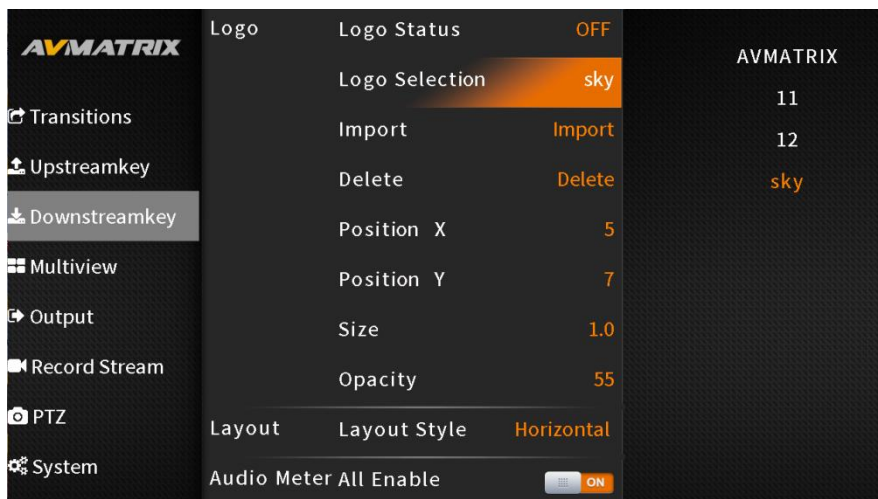

Choose from the following options to determine whether the logo key applies to PGM or PVW:

LOGO button **PVW**: Displays the logo on PVW

LOGO button **PGM**: Enables the logo on PGM

LOGO button **PVW&PGM**: Enables the logo on both PVW and PGM

LOGO button **OFF**: Disables the logo.



10. MULTIVIEW

The Multiview can be not only monitored through the build-in screen, but also can be monitored by connecting the HDMI Multiview output to an additional monitor for a larger view.

10.1. Multiview Layouts

The switcher offers two distinct multiview layouts, adaptable to your specific needs and preferences. You can effortlessly switch between a landscape and a portrait layout directly from the intuitive menu interface.

- Landscape mode:

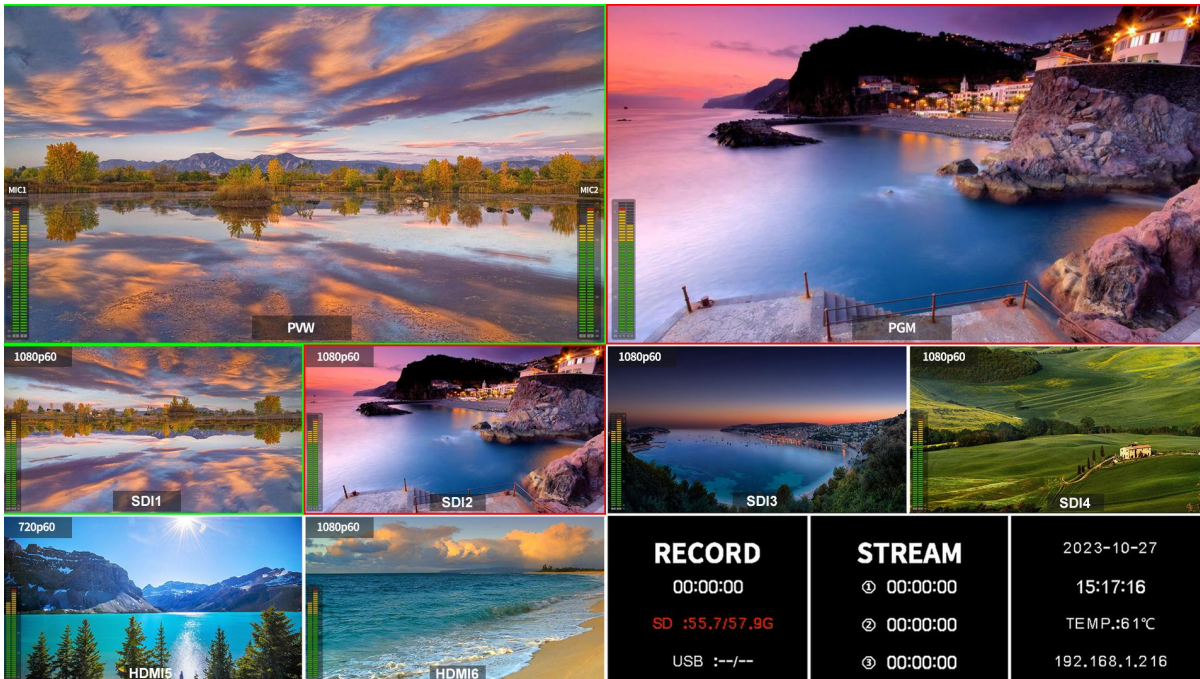

- Portrait mode:

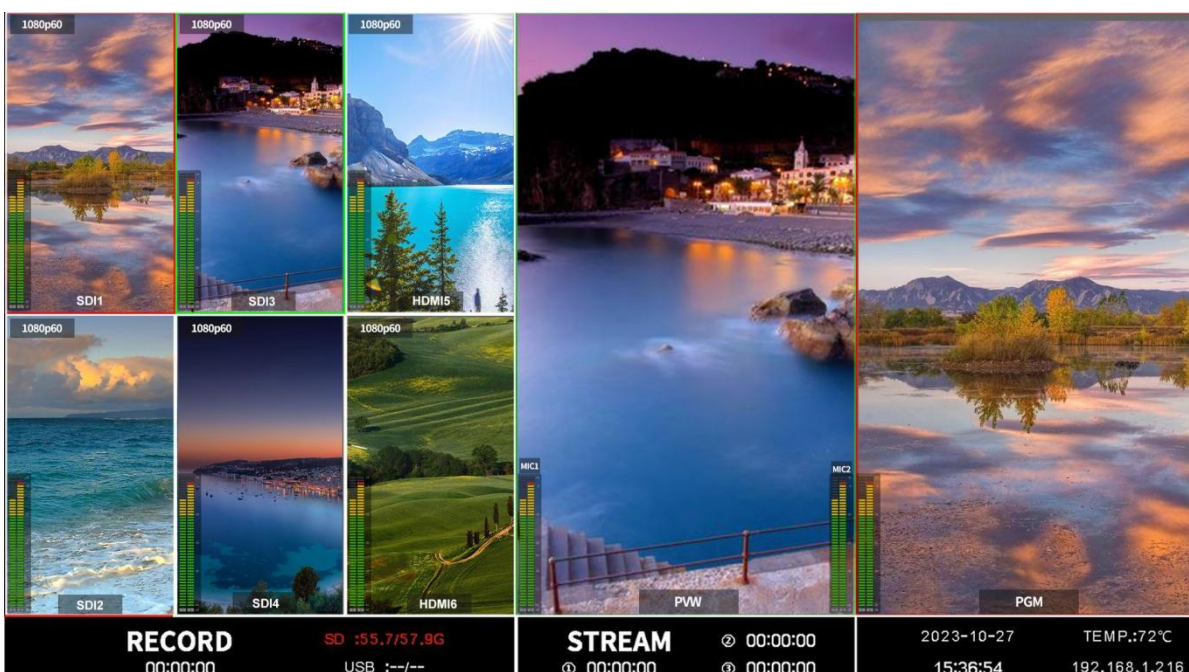

10.2. Audio Meter

Each window of the multiview features dedicated audio meters for SDI1-4, HDMI5-6, PGM, and MIC, providing real-time visual feedback on the audio status of each source. Additionally, the audio meters for MIC 1 and MIC 2 are conveniently positioned on the left and right sides of the PVW window. For added flexibility, users can enable or disable individual ones directly from the menu. The audio meter position can also be customized to appear on the left or right of each window.

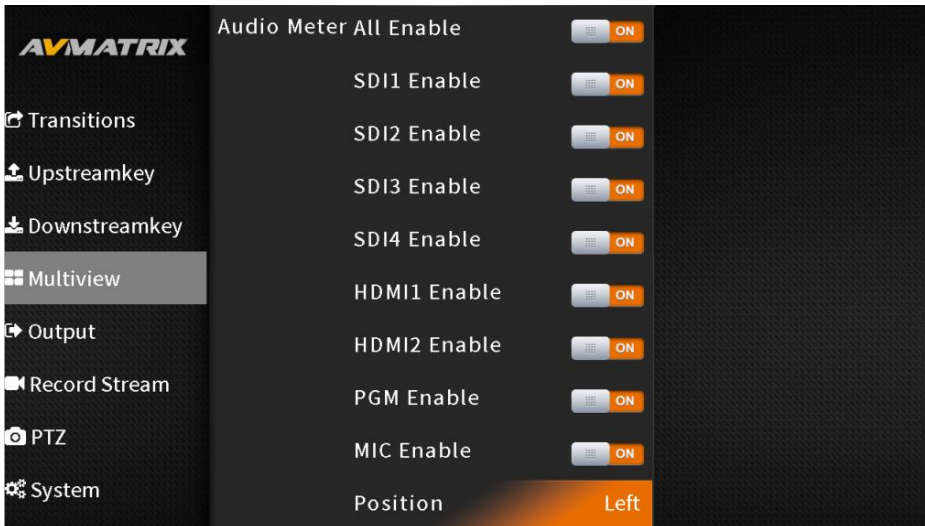

10.3. Input Information

Each window of SDI 1-4 and HDMI 5-6 displays the resolution and frame rate of the corresponding HDMI/SDI input signal. When enable the input mode, the information will be display on the right of each window. This valuable information allows users to quickly identify and verify the source signal at a glance.



For optimal visibility, users can tailor the overlay's opacity to their preference, choosing from four levels: 25%, 50%, 75%, or 100%. This flexibility ensures that the overlay remains informative without obscuring the underlying video content.

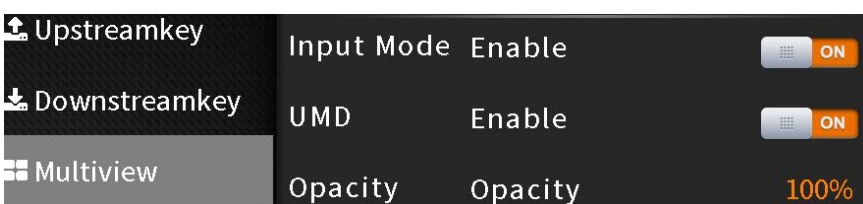

10.4. UMD Settings

The default UMD of the six inputs are SDI1, SDI2, SDI3, SDI4, HDMI5, HDMI6. Users have the flexibility to turn the UMDs on or off as needed. Additionally, the UMD's opacity can be adjusted to four levels: 25%, 50%, 75%, or 100%.

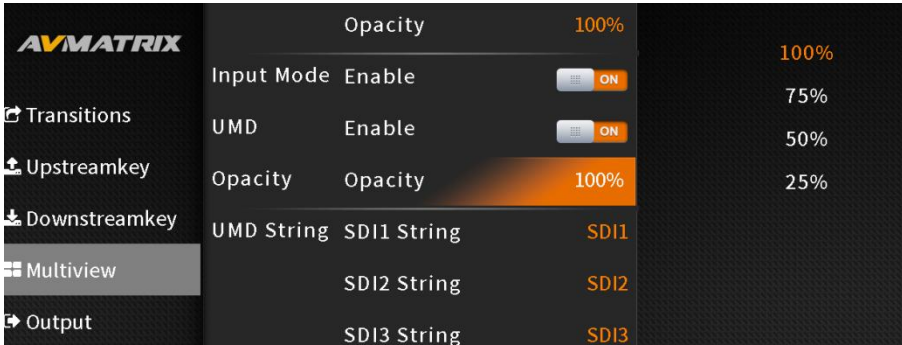

Tailor the UMD labels to your specific needs using the intuitive menu interface. With the virtual keyboard and rotary knob, you can effortlessly rename the UMD content for each window, accommodating up to 10 characters per label. Below image provides an example.

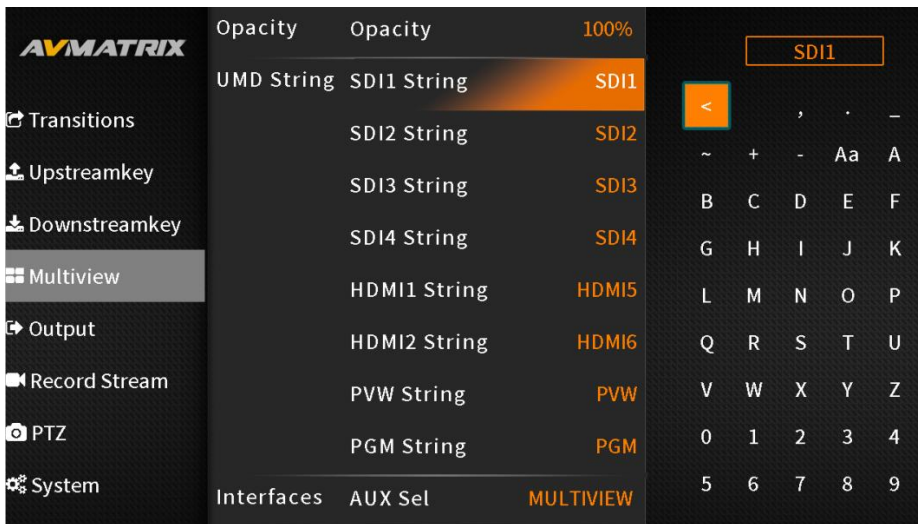

11. OUTPUT SETTINGS

11.1. Output Interfaces

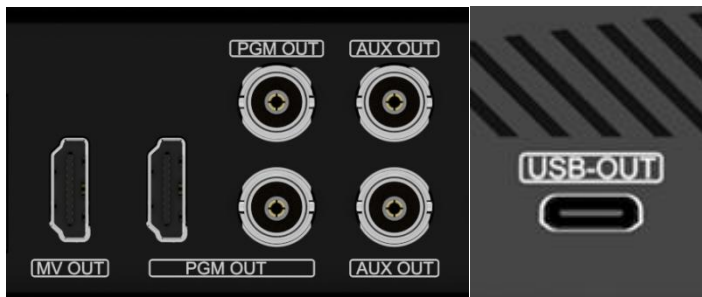

The switcher boasts a comprehensive range of output options, catering to diverse user requirements. It has 6 video output interfaces on the back of the switcher, 1 HDMI Multiview out, 2 SDI and 1 HDMI PGM outs, 2 AUX outs. And it has a USB-C port on the side of the switcher.

11.1.1. PGM Out

The video switcher has 2 SDI ports and 1 HDMI ports for PGM outputs. The multiple PGM outputs are flexible for users to connect the PGM signals to several devices for live streaming or monitoring.

11.1.2. Multiview Out

The HDMI multiview port's default output is the Multiview. Connect it to an additional LCD display to clearly monitor the 4 SDI, 2 HDMI inputs, PVW, PGM, and status interface.

11.1.3. AUX Out

The AUX OUTs can be configured to output SDI1, SDI2, SDI3, SDI4, HDMI5, HDMI6, PVW, PGM, Color Bar or Multiview out signal from the menu.

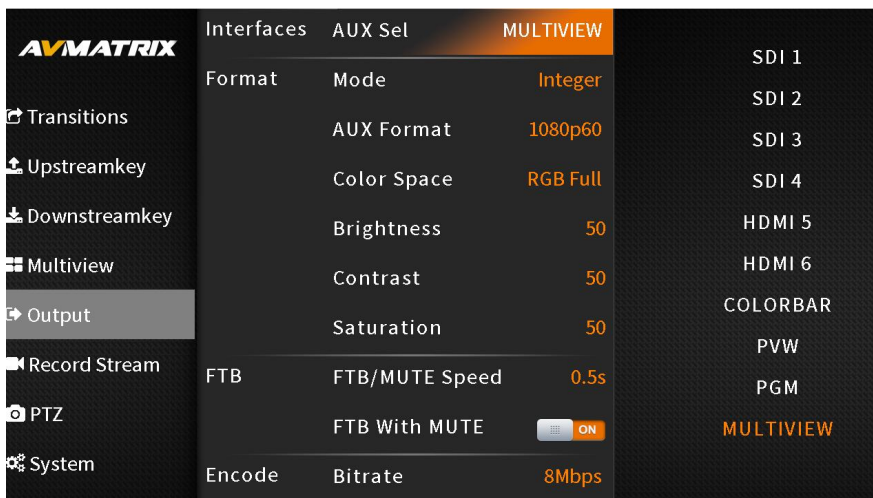

11.1.4. USB-C Out

Connecting the USB output to a PC with a type-C USB2.0 cable, user can use software like OBS, PotPlayer, VMix, etc. to play or store the captured USB Out video and audio on live streaming platforms like YouTube, Facebook, Twitter, etc. The USB2.0 streaming output is based on UVC (USB video class) and UAC (USB audio class) standard. No additional drivers need be installed. The relevant video and audio devices will be detected in the Windows Device Manager as below:

- **Under Imaging Devices:** USB Capture Video
- **Under Audio inputs and outputs:** USB Capture Audio

The default video source for USB out is the PGM output.

11.2. Output Format Settings

Configure the output format in the menu, including AUX format, color space, brightness, contrast, and saturation.

11.2.1. Output Format

The switcher supports up/ down scaling output. Besides, user can switch the Frame Rate Mode between

Integer or Decimal. When the Frame Rate Mode is integer, there are 1080i50, 1080i60, 1080p24, 1080p25, 1080p30, 1080p50, 1080p60 options available. When the Frame Rate Mode is Decimal, there are 1080i59.94, 1080p23.97, 1080p29.97, 1080p59.94 options available. The default format is 1080p60.

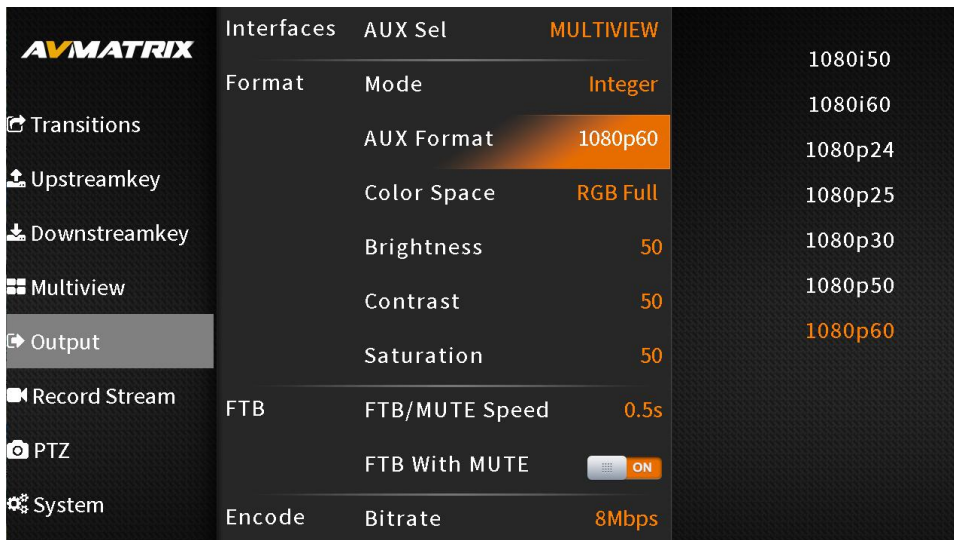

11.2.2. Output Color Space

The output color space can be set to YUV, RGB Full, or RGB Limited. The default color space for output is YUV.

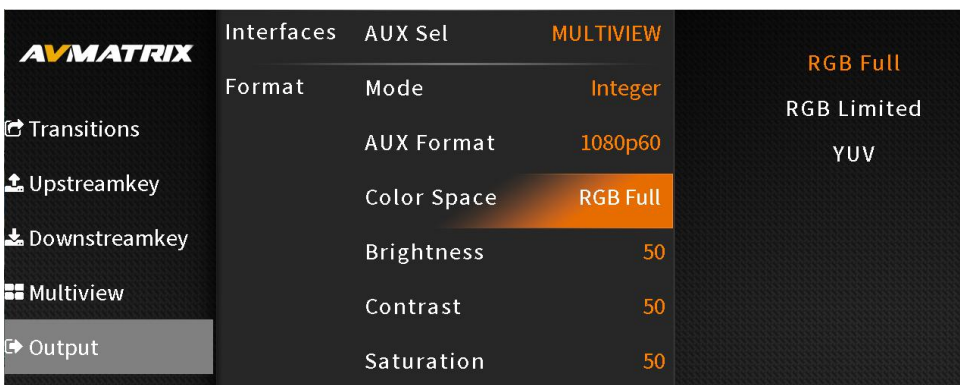

11.2.3. Output Image Settings

Adjust the output's brightness, contrast, and saturation in the menu. The setting range is from 0% to 100%. The default setting is 50%.

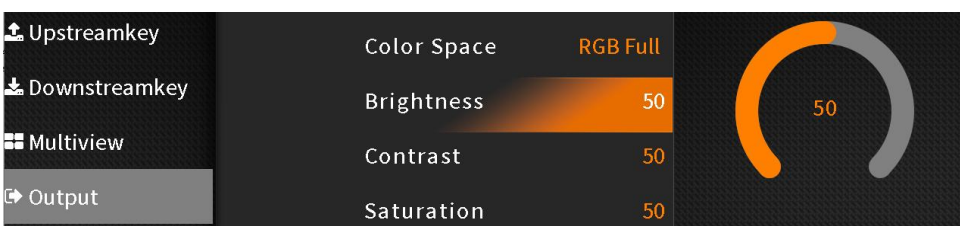

11.3. FTB

The FTB (Fade to Black) feature is designed for emergency situations during events. Pressing the FTB button will fade the PGM output to a black screen, concealing all other layers. The FTB button will continue to flash until the user presses it again to stop the FTB.

Note: If the PGM window displays a persistent black screen even after transitioning, check if the FTB button is flashing.

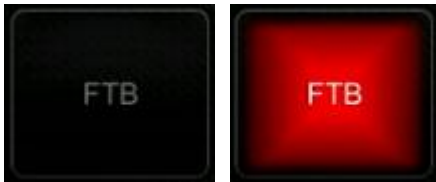

(1) FTB and Mute Speed Adjustment

The speed of FTB / MUTE can be adjusted from 0-3s in the menu. The speed is the time of whole transition for FTB and MUTE. For example, if the speed set to 2.5s the PGM video will be fading to black with audio becoming mute gradually in 2.5s.

(2) FTB with MUTE

Combining FTB and Mute is possible. Activate the FTB with Mute function from the menu, and the PGM will fade to black and mute simultaneously.

11.4. STILL

The video switcher supports the STILL function, allowing users to freeze input sources. Press the channel you want to freeze in the PGM or PVW row, then press the STILL button to freeze the input source. Multiple inputs can be frozen simultaneously. To unfreeze, press the input channel and STILL once more.

12. AUDIO SETTINGS

Press the AUDIO button on the panel to access the audio menu. The status page displays all audio states, and each multiview window features an audio graph for monitoring all audio states. Use the 3D joystick to select and adjust parameters and press the rotary knob to confirm the settings.



12.1. Master Audio

Master audio is an audio control for PGM output. It can be either mixed audio or AFV audio. User can turn on/off the master audio or adjust audio volume.

12.2. Audio Volume

User can independently adjust the audio volume for each audio including the master audio, earphone, MIC 1, MIC 2, as well as the 6 embedded input audios from SDI1, SDI2, SDI3, SDI, HDMI5 and HDMI6.

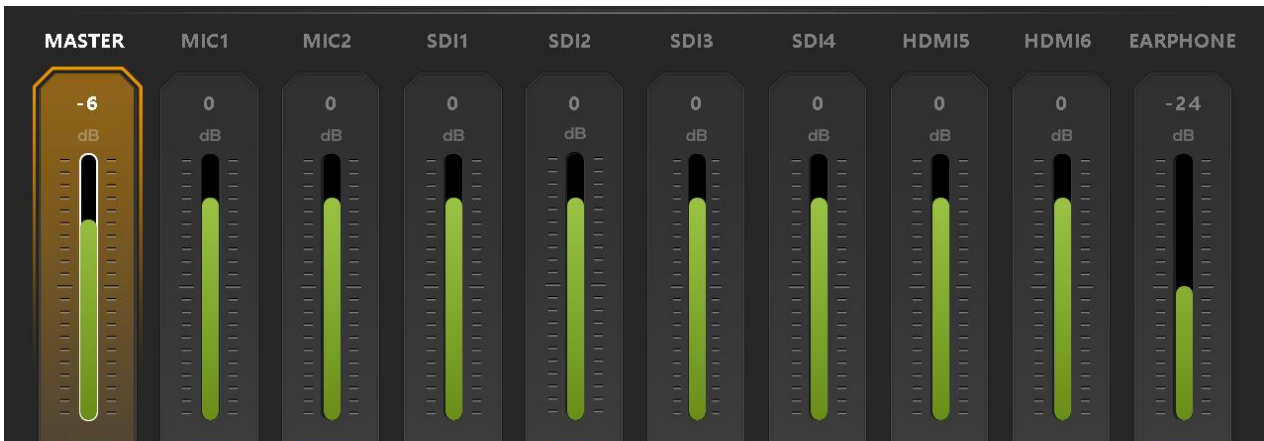

12.3. Audio On (MIX)

There is total 8 audios as the audio sources which can be mixed to PGM out, including 4SDI and 2 HDMI embedded audios and 2 MIC audio inputs. User can independently turn on/off each audio of SDI1, SDI2, SDI3, SDI, HDMI5, HDMI6, MIC1 and MIC2. When an audio turns on, the audio will be automatically mixed into the PGM output.

	Audio off;
	Audio on, AFV off;

12.4. AFV (Audio-Follow-Video)

Each channel of the 4 SDI and 2 HDMI embedded audios can be set to AFV. When one HDMI audio is set to AFV mode, it will only be turned on when the PGM output switches to that channel's video source. For example, if SDI 1 audio is set to AFV mode, the SDI 1 embedded audio will be turn on when the switcher switches SDI 1 as the video source of PGM.

	Audio on, AFV on & activated;
	Audio on, AFV on & nonactivated;

12.5. Audio Delay

The menu provides an audio delay setting for SDI1, SDI2, SDI3, SDI4, HDMI 5, HDMI 6, MIC 1 and MIC 2. User can adjust the audio delay to to achieve synchronization between audio and video. Each level of the audio delay setting corresponds to 5ms. The audio can be delayed by a maximum of 500ms.

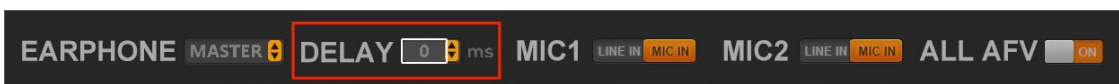

12.6. MIC

The switcher has two MIC inputs that user can connect it with a line-level or a microphone device, and turn on/off, adjust the audio volume and delay level.



12.7. Earphone

The switcher provides an earphone output for monitoring individual audio sources. User can select an audio source for the Earphone from Master audio, 4 SDI and 2 HDMI embedded audios, or 2 MIC audios. Users can turn on/off the Earphone or adjust audio volume.

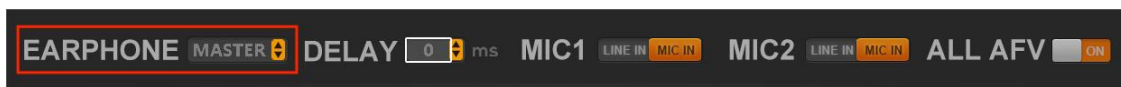

13. STREAM & RECORD

13.1. Streaming

The switcher supports two live streaming methods: USB output and Ethernet port output. Users can choose the desired stream mode in the stream settings.

The USB Type-C port enables video capture to a computer and live streaming through software like OBS or PotPlayer. The LAN port facilitates direct live streaming to platforms using an IP address. The maximum bitrate for streaming is 32Mbps. It can live stream to 3 platform at the same time.

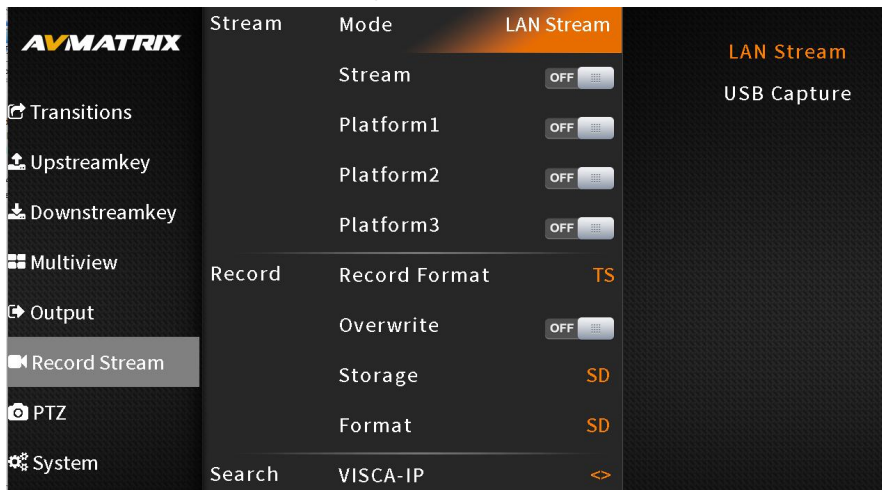

Network Push Streaming:

Step 1: Adjust the Bitrate, Rate Control, Encoding, Resolution, and FPS of the live video in the video settings according to network conditions. For instance, if the network speed is slow, switch the Bitrate Control from CBR to VBR and adjust the Bitrate accordingly. These settings can also be modified through the web page.

After the finish the configuration, select the stream mode "LAN Stream", and we can enable the stream from the menu or Stream button on the switcher's control panel.

Encod	Bitrate	8mbps	2mbps
	Rate Control	VBR	4mbps
	Video Encoding	H.264 High	8mbps
	Resolution	1920x1080	12mbps
	FPS	60	16mbps
	I-Frame Interval	30	24mbps
	Sampling Rate	48kHz	32mbps
	Audio Bitrate	256kbps	

Step 2: Access the live streaming settings of the stream platform and obtain and copy the Stream URL and streaming key.

Stream key

Select stream key

Default stream key (RTMP, Variable) ▾

Stream key (paste in encoder)

Stream URL

Backup server URL

YouTube also supports RTMPS for secure connections. [Learn more](#)

Step 3: Access the switcher's web page by entering its IP address (192.168.1.216) into a web browser and login the account (Name: admin, Password: admin). Select "Stream settings" section, paste the Stream URL and streaming key into the designated fields. Enable the "Start" option and click "Save&Apply" to initiate the live stream. Navigate to the live streaming platform to view the broadcast. Users can also customize the main stream and sub-stream names as desired.

Push Stream Start Streaming

Stream Media	Status	Custom Name	Address	Action
RTMP	Running	MainRTMPRemote	rtmp://a.rtmp.youtube.com/live2/sdfyhauiefhaw	On
RTMP	Stop	SubRTMPRemote	rtmp://192.168.1.7:1935/live/av1	Off
RTMP	Stop	ThirdRTMPRemote	rtmp://192.168.1.8:1935/live/av2	Off
SRT	Stop	MainSrtRemote	192.168.1.216	Off

^ 1 v

Edit RTMP stream

Protocol Type:

* Custom Name:

* URL:

No

Once the streaming status in the Multiview status page turns green, the live streaming starts, and streaming time starts to count. You can stream to three different platforms at the same time.

<p>RECORD</p> <p>00:00:00</p> <p>SD :55.7/57.9G</p> <p>USB :--/--</p>	<p>STREAM</p> <p>① 00:00:00</p> <p>② 00:00:00</p> <p>③ 00:00:00</p>	<p>2023-10-27</p> <p>16:36:21</p> <p>TEMP.:58°C</p> <p>192.168.1.216</p>
--	--	--

Local Pull Streaming:

Access the switcher's web page by entering its IP address (192.168.1.216) into a web browser and login the account (Name: admin, Password: admin). Select "Stream settings" section, and obtain and copy the local address URL for pull streaming. Open a video player app like OBS, PotPlayer or Vmix and paste the local address URL into the designated field to initiate the local streaming.

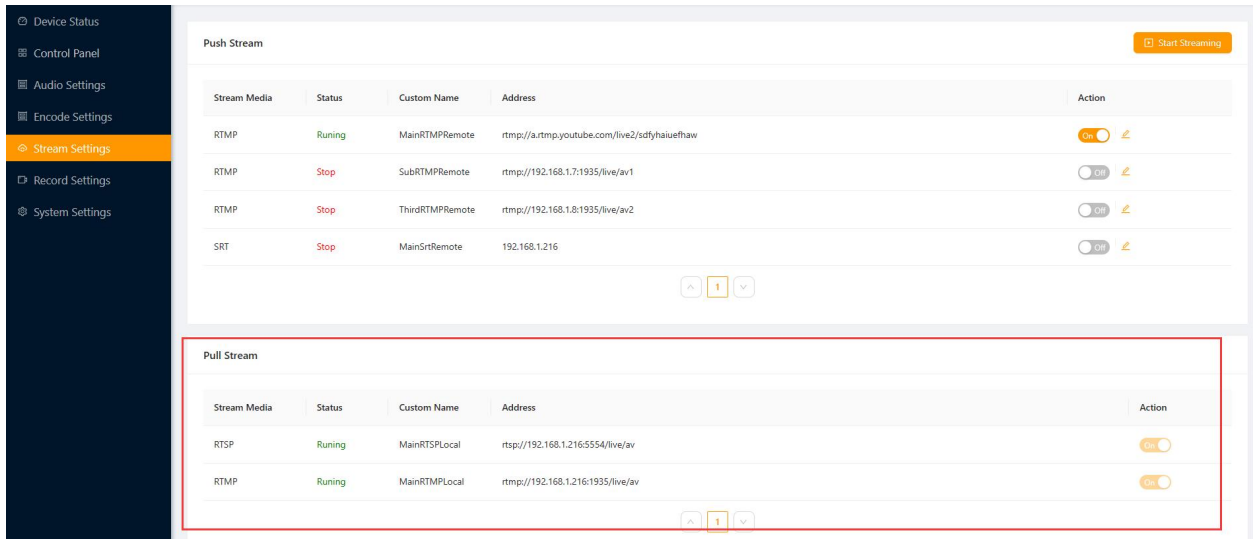

Using OBS as an example

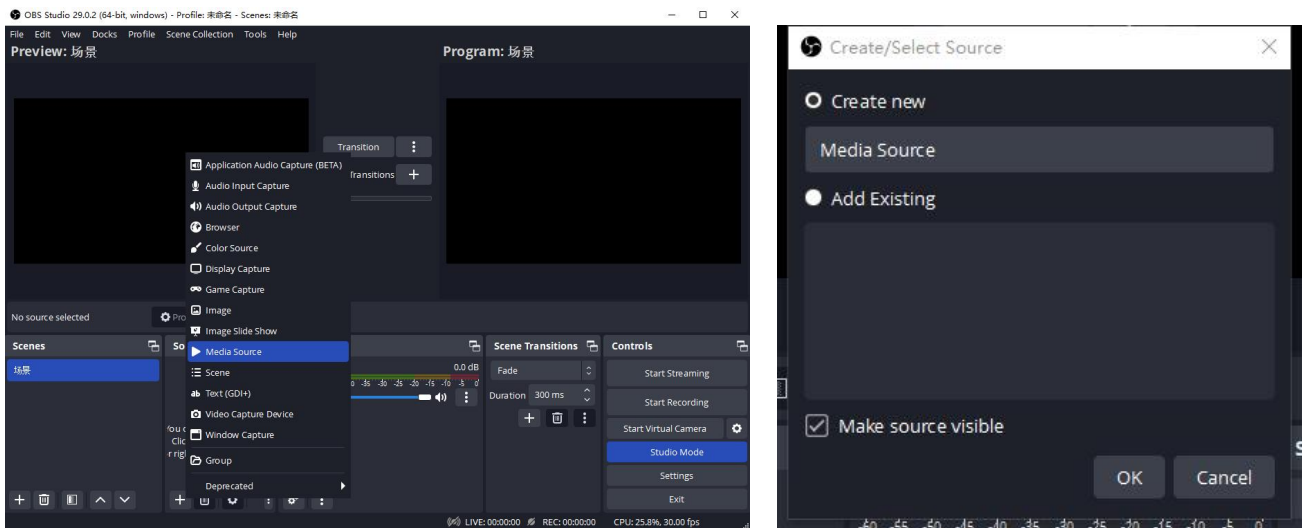

Step1: Open OBS Studio. Click the "+" icon in the "Sources" section and select "Media Source" to add a new media source."

Step 2: Disable the local file setting, paste the "local address URL" into the "Input" field, and click "OK" to complete the local streaming setup.

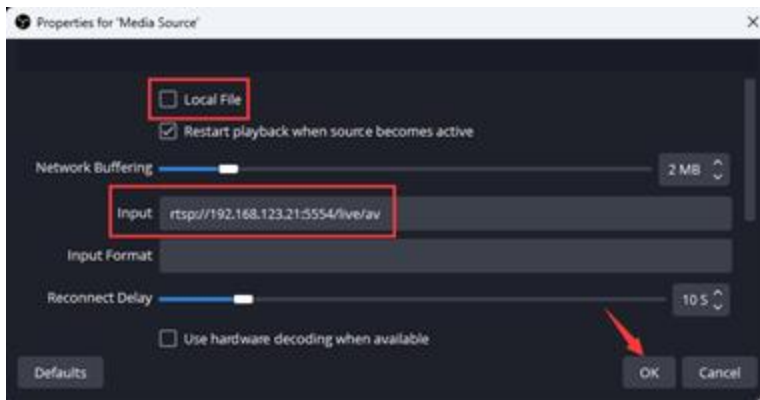

How to Play the RTSP Stream Using VLC Player:

Step 1: Open VLC Player, and click the "Media" section and select "Open Network Stream".

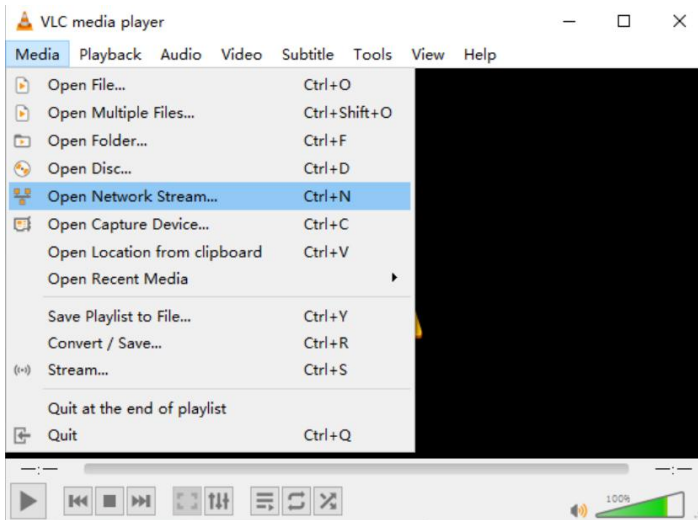

Step 2: Enter the RTSP address of the stream in the "Network" section of the pop-up window.

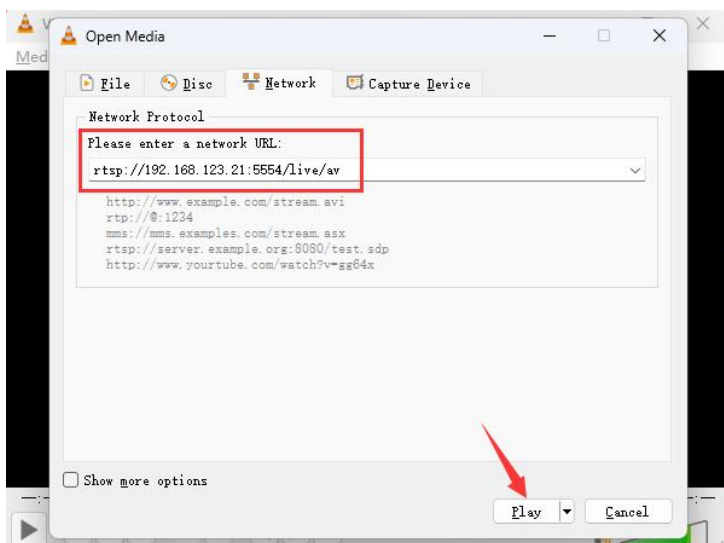

13.2. Recording

The switcher offers two recording methods: via USB disk or SD card. Insert the desired storage device and select it in the recording settings. Press the REC button on the panel to initiate recording. The recording status will display device information. Users can also choose between MP4 and TS recording formats in the settings.



Storage Settings

Off Overwrite Mode Save

Record Format: TS Split Recording File: 60 mins

Record Storage: SD Card | USB Disk

When recording starts, the recording indicator light on the status page turns red, and the recording time begins counting in the multiview. To stop recording, press the REC button again. The recording status displays the recording time, SD card/USB disk status, and the selected storage device turns red for easy identification.

RECORD	STREAM	2023-10-27
00:00:05	① 00:00:00	16:37:04
SD :55.7/57.9G	② 00:00:00	TEMP.:59°C
USB :--/--	③ 00:00:00	192.168.1.216

Formatting Storage Devices

Users can format their USB disk or SD card through the menu. In the recording menu, select either "Format USB" or "Format SD card" to begin formatting the respective storage device. The default formatted file system is exFAT. Formatting will permanently erase all data on the disk, so please back up important data beforehand.

Overwrite Function

The switcher's recording feature has an optional overwrite function. When the SD card or USB disk memory is full, the overwrite function automatically deletes and overwrites previously recorded content with the new recording. Users can enable or disable the overwrite function in the menu.

14. PTZ CONTROL

The video switcher has a feature that control PTZ cameras through LAN port or serial port. Utilize the joystick and buttons to pan, tilt, or zoom individual cameras. Protocols supports: VISCA, VISCA over IP, Pelco D/P, and Onvif..

For LAN port connection, ensure DHCP is enabled, and so we put them on the same LAN. Search the camera through VISCA-IP or ONVIF from menu, and then we can add the camera we searched into a camera ID. If the working environment doesn't have DHCP for network, we can change the IP address of the switcher from menu to set them in a same LAN, so that the switcher can search the camera successfully.

Access the PTZ menu using the joystick knob, search for the camera, select the camera to be connected, and customize the camera ID if desired. And select the corresponding protocol from the menu that there are VISCA-IP and Onvif available for network connection. Last, toggle the connection switch to establish the connection.

There are 3 ways we can call the camera we want to control:

1. Set the call option to Follow PGM, which means the controlled camera is same to the selected PGM channels from Camera 1-6. For example, when the PGM is selected the Camera 2 (IN 2), then the Camera 2 is under control.
2. Set the call option to Follow PVW, which means the controlled camera is same to the selected PGM channels from Camera 1-6. For example, when the PVW is selected the Camera 2 (IN 2), then the Camera 2 is under control.
3. If set the call option to Camera ID, then we can set the ID option from camera 1-6.

For connection through serial port, select the corresponding protocols from VISCA, PELCO-D, PELCO-P, and camera ID, and baud rate, serial port type settings. Subsequently, enable the connection switch to establish the connection.

Once the camera is connected, employ the 3D joystick to control camera movement. The zoom function can be operated using the zoom + or zoom - buttons on the panel. We also can adjust the Pan/Tilt/Zoom speed in the PTZ menu as needed.

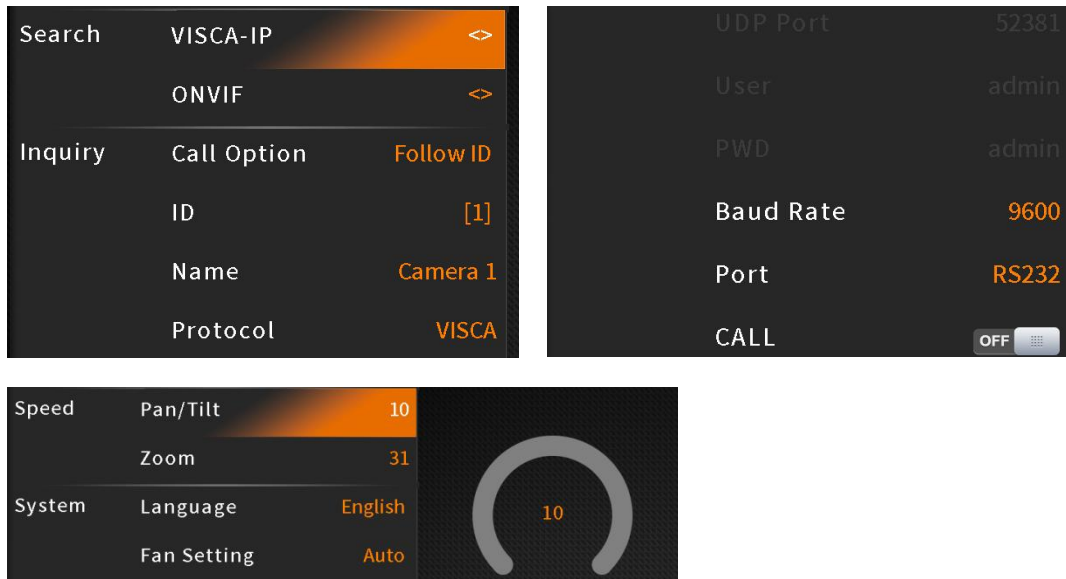

15. SYSTEM SETTINGS

15.1. Language

Switch between English and Chinese by accessing the system settings menu.

15.2. Fan Settings

Control the switcher's temperature and noise by adjusting the cooling fan speed. The speed can be set from 0% to 100% that when it is 0% the fan off, when it is 100% the fan is in AUTO mode.

In AUTO mode, the fan speed automatically adjusts based on the switcher's operating temperature. For applications requiring silent operation, the fan can be manually turned off via the menu.

If the operating temperature reaches 57°C, a warning message will appear in orange at the bottom of the Status/Menu page. At 60°C, the fan will automatically switch to high speed to quickly cool the CPU and return to AUTO mode simultaneously.

15.3. ROC Correction

When the joystick needs to be calibrated, can access from the menu to celebrate the joystick for a correct PTZ control. During the calibration there is a notice that "The joystick is being calibrated. Please do not touch until the calibration is complete."

15.4. System Reset

Reset Preferences: Restore settings to default values, except for Media library, Time, Network, Language, Fan and User Setting.

Factory Reset: Restore all settings to factory defaults.

15.5. Version

Check the switcher's Software Version, FPGA Version, SYS Version, PCB Version, HDMI Version and Key.

15.6. Time Settings

15.6.1. Manual Time Setting

Set Year/ Month/ Day/ Hour/ Minute directly through the Menu. Choose between 12h and 24h time formats. The default setting is 12h.

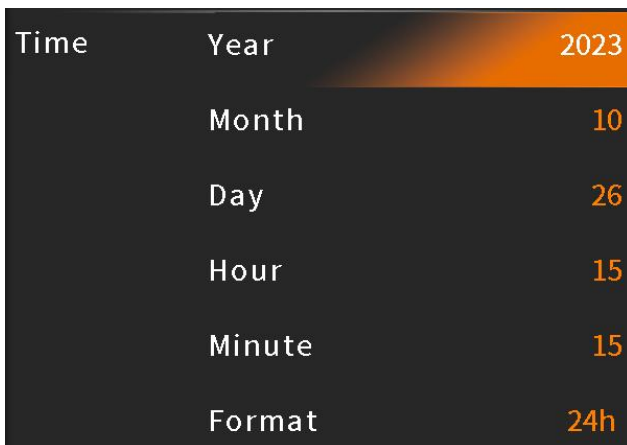

Time	Year	2023
	Month	10
	Day	26
	Hour	15
	Minute	15
	Format	24h

15.6.2. Time Synchronization

Connect the video switcher to a window PC via LAN cable. Open a web browser and locate the switcher's web control page. On the web page, select the time setting, which can be synchronized automatically or set manually.

15.7. Network Settings

The video switcher supports two methods for acquiring an IP address: Dynamic (DHCP-assigned IP) and Static (user-configured IP). Choose the desired method from the menu. The default setting is Dynamic.

Dynamic (DHCP): Connect the video switcher to a DHCP-enabled router, and it will automatically obtain an IP address. Ensure the video switcher and PC are on the same local area network.

Static (Manual IP Configuration): Select the Static IP acquisition method when the network lacks DHCP functionality. Connect the video switcher to a PC via a network cable. Configure the PC's IP address to be within the same subnet as the video switcher's (default IP: 192.168.1.216) or vice versa.

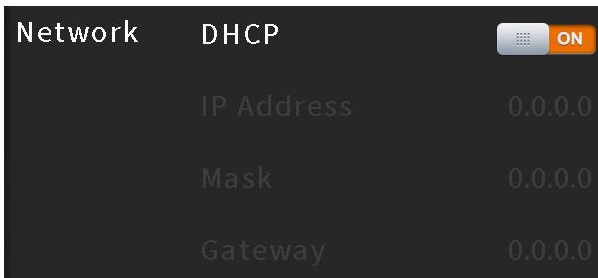

15.8. Customize Shortcut Keys

In the system menu, you can customize the shortcut keys for PIP1, PIP2, POP, chroma key, DSK, and LOGO buttons. For instance, assigning the PIP1 key to "PGM" will activate PIP1 directly on the PGM output when pressed. Similarly, setting PIP1 to "PVW" will activate it on the PVW output. Alternatively, assigning PIP1 to "MENU" will display a shortcut selection menu, allowing users to choose whether to apply the effect to PGM or PVW.

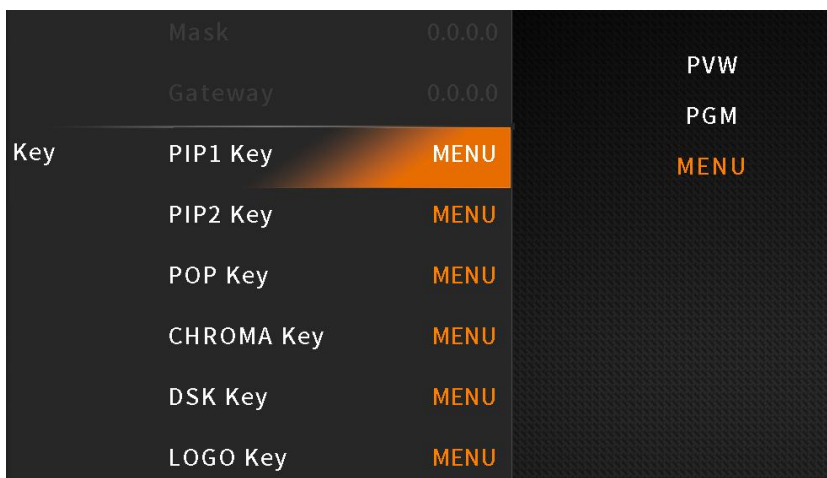

15.9. User Settings

The video switcher allows users to save current settings into accounts. Manage user accounts by adding new ones, renaming existing ones, switching between accounts, and deleting unnecessary ones.

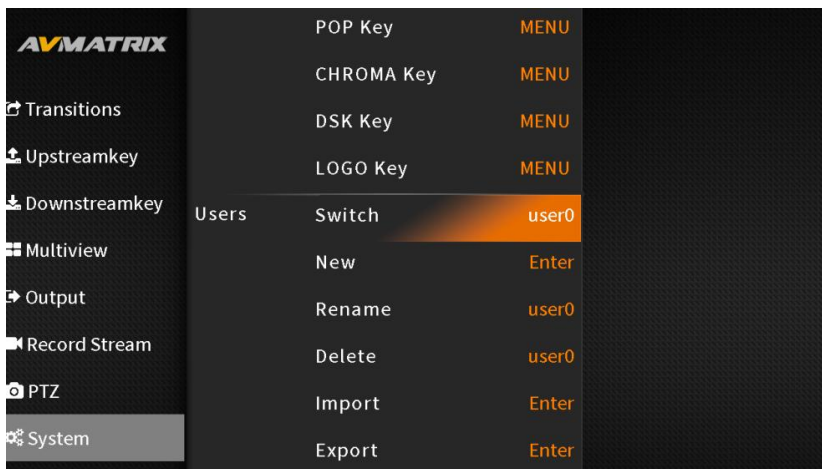

15.9.1. New

Create a new user account and save all current settings to it. Enter the account name using the virtual keyboard provided in the menu.

15.9.2. Rename

Modify the name of the currently selected user account.

15.9.3. Delete

Delete a saved user account which is no longer needed.

15.9.4. Import

Import the current user account and its settings from a USB flash disk.

15.9.5. Export

Export the selected user account and its settings to a USB flash disk for backup or transfer.

16. WEB CONTROL INTERFACE

Setup the switcher referring to Part 14.6. Network Settings. Access the switcher's web page by entering its IP address (192.168.1.216) into a web browser and login the account (Name: admin, Password: admin). All the settings can be configured from the sections of Device Status, Control Panel, Audio Settings, Encode Settings, Stream Settings, Record Settings, System Settings.

Device Status:

The screenshot displays the 'Device Status' interface for the AVMATRIX 6CH SWITCHER. It features a sidebar with navigation options: Device Status (selected), Control Panel, Audio Settings, Encode Settings, Stream Settings, Record Settings, and System Settings. The main content area is divided into several sections:

- Preview:** A large black rectangular area with a 'Play' button.
- Network Speed (Mb/s):** A line graph showing network activity, with a current value of 0.863 Mb/s.
- Stream Status:** Three RTMPRemote streams are shown, each with a '00:00:00' timer and a 'Stream' button.
- Hardware Status:** Three circular gauges indicate system health: RAM at 36.27%, CPU at 38%, and TEMP at 72°C.
- Record Status:** Two recording slots are shown, both with '00:00:00' timers and 'Record' buttons. The first is labeled 'SD: No Disk' and the second 'USB: No Disk'.
- System Info:** A table at the bottom right provides details on Video Input (FPGA 1920x1080@60P), Output Mode (LAN 1920*1080P60), Audio Input (FPGA 24Bits/48kHz), and Runtime (00:41:00).

Control Panel:

The screenshot displays the 'Control Panel' interface for the AVMATRIX 6CH SWITCHER. It features a sidebar with navigation options: Device Status, Control Panel (selected), Audio Settings, Encode Settings, Stream Settings, Record Settings, and System Settings. The main content area is divided into several control sections:

- USK:** Controls for Picture-in-Picture (PIP1, PIP2, POP, CHROMA) and 'ON AIR' indicators.
- DSK:** Controls for DSK, LOGO, and 'ON AIR' indicators.
- FTB:** Controls for FTB, a 0.5 s timer, and MUTE.
- PMG:** Controls for Program Memory Groups (1-6), BAR, and STILL.
- PVW:** Controls for Preview Windows (1-6), BAR, and STILL.
- Transition:** Controls for transition types (MIX, DIP, WIPE, CUT, AUTO) and a 0.5 s timer.
- Vertical Slider:** A vertical slider control with a black knob.
- Key List:** A list of keys including Upstream Key, Downstream Key, Transition, Multiview, and Output.

Audio Settings:

Encode Settings:

Stream Settings:

The screenshot shows the 'Stream Settings' page for a 6CH SWITCHER. The left sidebar includes: Device Status, Control Panel, Audio Settings, Encode Settings, Stream Settings (highlighted), Record Settings, and System Settings. The main area is divided into 'Push Stream' and 'Pull Stream' sections, each with a 'Start Streaming' button and a table of stream configurations.

Stream Media	Status	Custom Name	Address	Action
RTMP	Stop	MainRTMPRemote	rtmp://live-push.bilibili.com/live-bvc/?streamname=live_1636010410_21052986&key=f6d9f829a56cbe5c6b47b22a32ae5978&schedule=rtmp&pflag=1	Off
RTMP	Stop	SubRTMPRemote	rtmp://192.168.1.7:1935/live/av1	Off
RTMP	Stop	ThirdRTMPRemote	rtmp://192.168.1.8:1935/live/av2	Off
SRT	Stop	MainSrtRemote	192.168.123.21	Off

Stream Media	Status	Custom Name	Address	Action
RTSP	Runing	MainRTSPLocal	rtsp://192.168.123.21:5554/live/av	On
RTMP	Runing	MainRTMPLocal	rtmp://192.168.123.21:1935/live/av	On

Record Settings:

The screenshot shows the 'Record Settings' page. The 'Disk Management' section displays SD Card and USB Disk status with 'Free: 0G' and 'Total: 0G' indicators and 'Refresh' and 'Format' buttons. The 'Storage Settings' section includes an 'Overwrite Mode' toggle, 'Record Format' (TS), 'Split Recording File' (60 mins), and 'Record Storage' (SD Card and USB Disk).

Attention: Do you want to format this disk to EXFAT? Formatting will erase all data on the disk and cannot be recovered. Please back up important data before proceeding.

System Settings:

The screenshot shows the 'System Settings' page with the 'Device Info' tab selected. The fields are as follows:

Device Name: 6CH_SWITCHER	Device No.: 06f2b312f3f428a9	Mac Address: 3c6a2cd3e745	IP Address: 192.168.123.21
Hardware Ver.: VS0605E-PRO_V3.2-20230616	Device Ver.: V1.0.1.28	FPGA Ver.: V1.0.10	Authorization Status: Authorized

The screenshot shows the 'System Settings' page with the 'System Maintenance' tab selected. It features an 'Upgrade' section with 'Upload' and 'Upgrade' buttons, and an 'Import Settings' section with 'Upload' and 'Import' buttons. On the right, there are buttons for 'Export Settings', 'Export Log', 'Reset', and 'Reboot'.



- Device Status
- Control Panel
- Audio Settings
- Encode Settings
- Stream Settings
- Record Settings
- System Settings

6CH SWITCHER

English Logout

Device Info. System Maintenance **Network Settings** Time Settings Password Settings

DHCP

IP Address <input type="text" value="192.168.123.30"/>	Sub Mask <input type="text" value="255.255.255.0"/>	GateWay <input type="text" value="192.168.123.1"/>
DNS 1 <input type="text" value="218.85.152.99"/>	DNS 2 <input type="text" value="223.5.5.5"/>	

Save



- Device Status
- Control Panel
- Audio Settings
- Encode Settings
- Stream Settings
- Record Settings
- System Settings

6CH SWITCHER

English Logout

Device Info. System Maintenance Network Settings **Time Settings** Password Settings

Summer Time Auto-sync Time Manual Settings

Time Zone <input type="text" value="(UTC+08:00) Beijing, Chongqing, Hong Kong, Urumqi"/>	Manual Setting <input type="text" value="请选择日期"/> <input type="checkbox"/> Local Sync
NTP Server <input type="text" value="pool.ntp.org"/>	Sync Interval(Min) <input type="text" value="60"/>
Devices Time <input type="text" value="2023-12-06 16:52:13"/> Save	



- Device Status
- Control Panel
- Audio Settings
- Encode Settings
- Stream Settings
- Record Settings
- System Settings

6CH SWITCHER

English Logout

Device Info. System Maintenance Network Settings Time Settings **Password Settings**

Old Password

New Password

Confirm Password
 Save

Note: Please enter 3-16 characters, supporting uppercase and lowercase letters, numbers, hyphens, and underscores.